

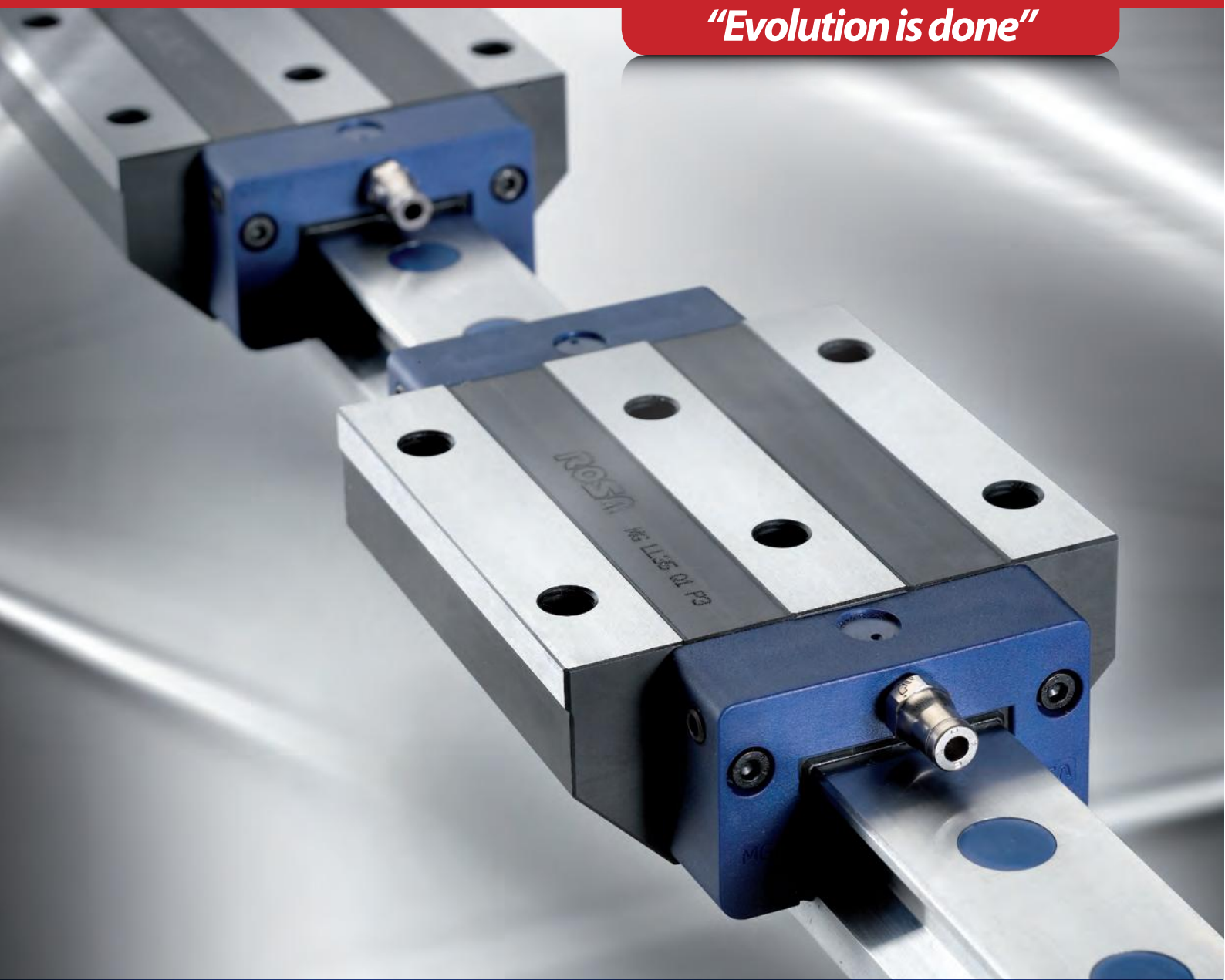

MG Monoguide recirculating linear rollers bearing

Next generation

"Evolution is done"





Grinding machine mod. PLATINUM TH made from Rosa Erando SpA
for MG monoguide slide ways finishing

INDEX

1.

1.

PRODUCT DESCRIPTION AND FEATURES OF MG MONOGUIDES

Product identification codes p. 8

2.

1.
2.
3.
4.
5.
6.
7.
8.
9.
10.
11.
12.
13.

GENERAL TECHNICAL DATA

Accuracy classes and tolerances p. 10
Sliding accuracy p. 10
Preload classes p. 10
Allowed acceleration and speed p. 11
Operating temperatures p. 11
Construction materials p. 11
HCP anticorrosion coating p. 11
Size tables p. 12
Static and dynamic load capacity, Allowable moments p. 14
Top lubrication – Size table p. 15
Guides that can be screwed from the bottom p. 15
Life p. 16
Stiffness diagram p. 18

3.

1.
2.

DESIGN OF THE RECIRCULATING LINEAR ROLLER BEARING MONOGUIDE

Calculation base - Definition of dynamic and static loads and allowable moments p. 28
Calculation programme to design the monoguide p. 32

4.

ACCESSORIES p. 35

5.

1.
2.
3.

LUBRICATION

Greasing p. 43
Oiling p. 43
Lubrication accessories p. 46

6.

1.
2.
3.

INSTALLATION AND ASSEMBLY

Fastening instructions p. 48
Accuracy of assembly surfaces p. 50
Assembly types p. 51

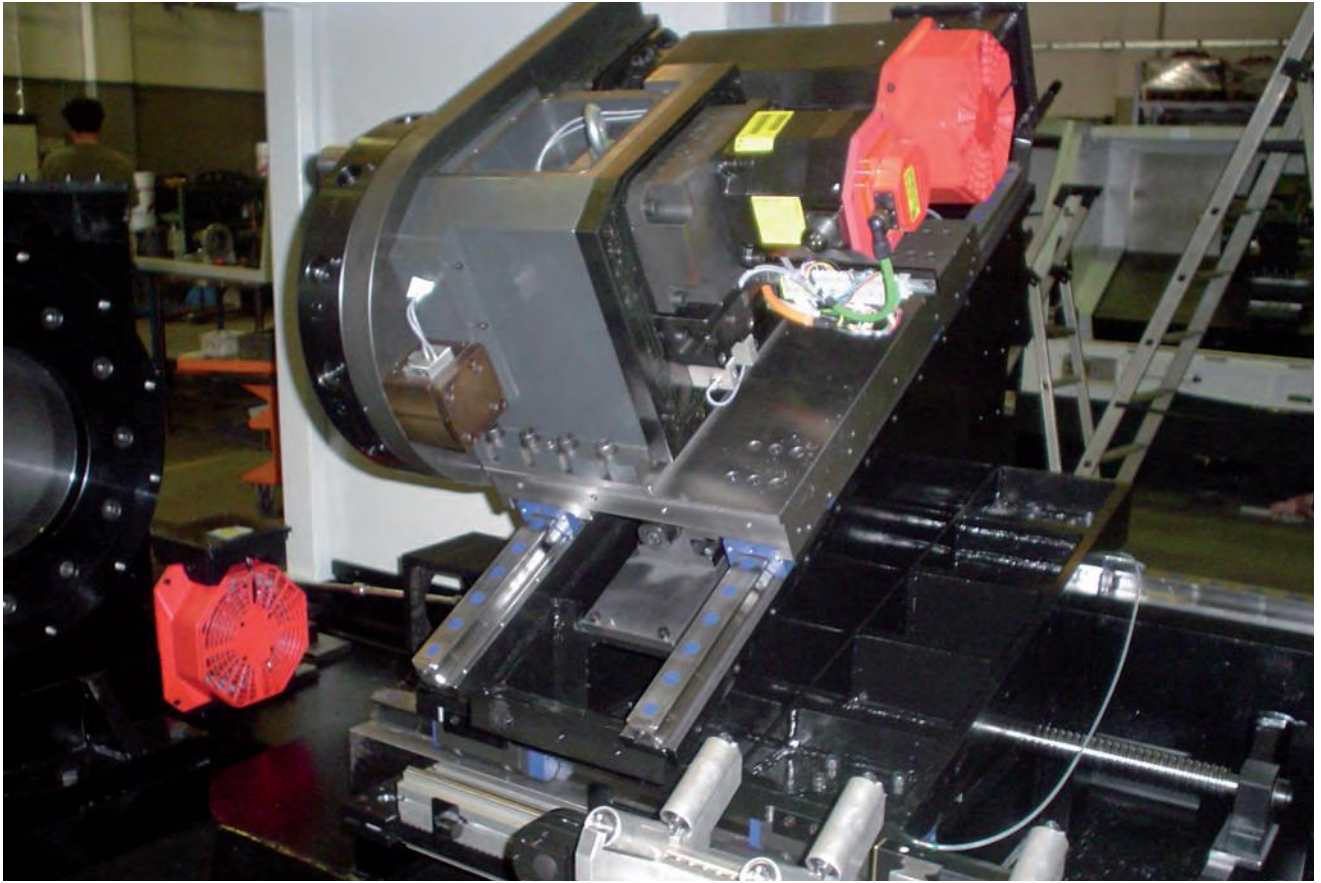

MG 45 LC Monoguide on CNC lathe (Tecno V photos - kind permit)

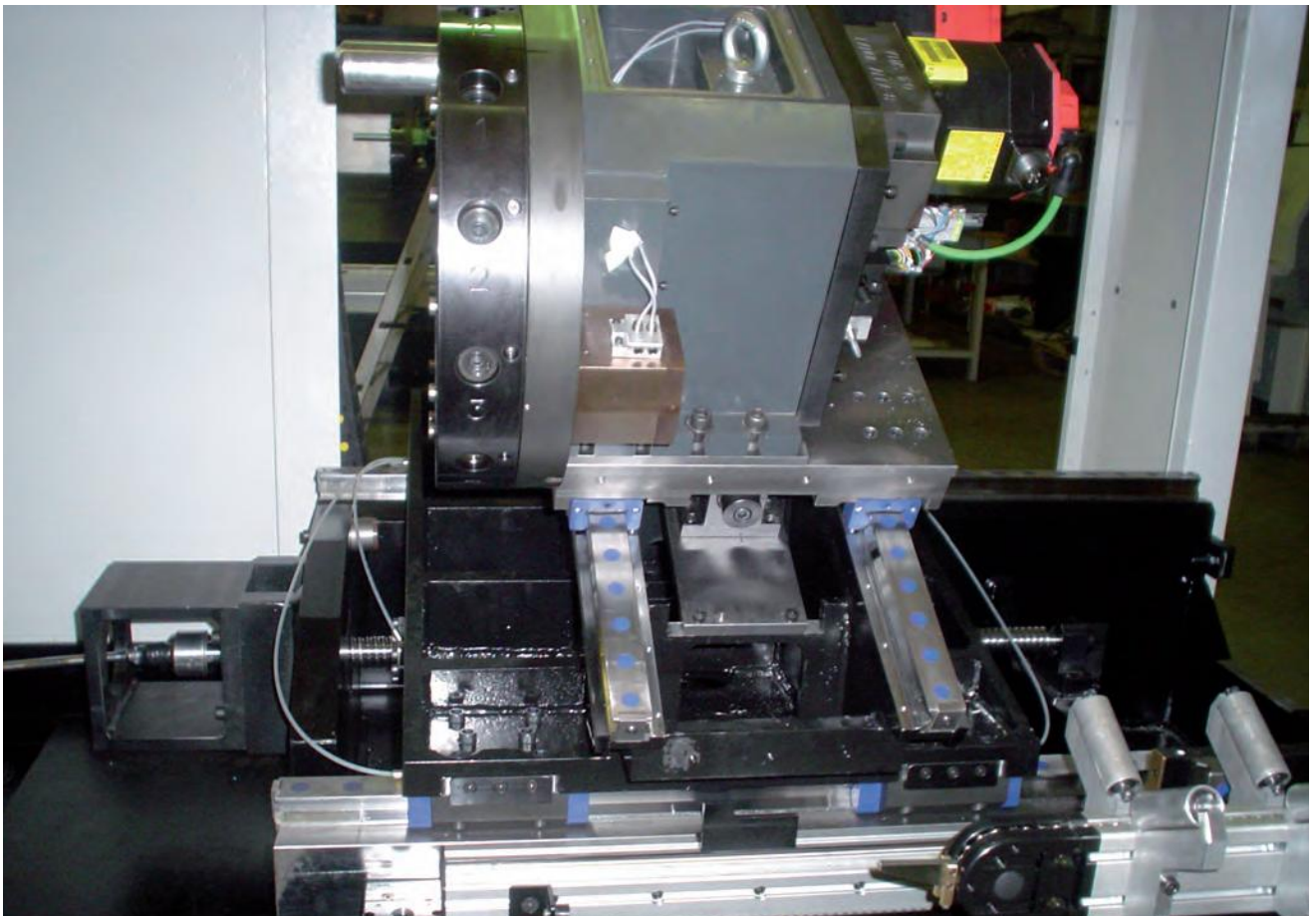

1.

MG MONOGUIDE PRODUCT DESCRIPTION AND FEATURES

1. Product identification codes

The new MG monoguide manufactured by Rosa Sistemi is an advanced technical solution for high-tech industries. The monoguide is suitable for high loads, great stiffness and high reliability, especially for machine tools.

STREAMLINED ROLLER SLIDE WAYS

The geometries and the directions of the roller slide ways were calculated by means of FEM according to each individual preload, thus assuring the best performances of load capacities and obtainable accuracies all the time.

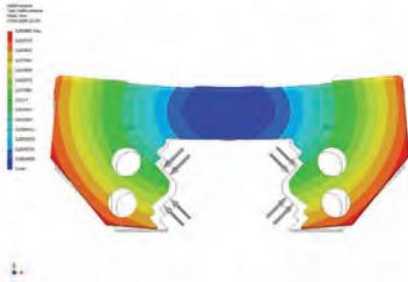

ROLLERS WITH LOGARITHMIC PROFILE

The rollers are manufactured according to the most recent knowledge about rolling element-related theory, thus assuring high stiffness, maximum load capacity and long life.

INNOVATORY LUBRICATION SYSTEM

The introduction of the lubricant into the front head is controlled by means of check valves. These valves are installed on both sides of the carriage slide ways and prevent the lubricant from flowing back while sliding. With minimum quantities of lubricant, independently from the assembly position, the perfect distribution over the slide ways will be assured.

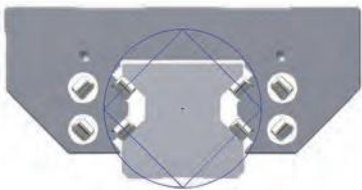

LUBRICATION VERSATILITY

Each front head of the carriage has 4 lubrication inputs: two side inputs, one front input and one on the other side.

SLIDING UNIFORMITY

Thanks to streamlined radiuses for internal recirculating systems, pulsation phenomena are reduced to the minimum, thus offering a low resistance to the forward movement.

INNOVATORY DESIGN

The accurate study of all plastic elements in the carriage enabled reduced the interferences in the internal recirculating systems, thus increasing relevant reliability and life.



PROTECTION OF THE CARRIAGE

The slide ways are well protected by means of cross-wise and longitudinal gaskets that assure good sealing (also in contaminated environments).

INTERCHANGEABILITY

The narrow construction tolerances assure the interchangeability of the carriages. Both sides of the guide can be used as a reference.

ADDITIONAL PROTECTIONS

Upon demand, it is possible to supply additional wipers and scrapers.

LONG - LIFE LUBRICATION

A specific additional head allows long lubrication duration, thus preventing additional costs for the purchase of a lubrication station.

ANTICORROSION COATING

The carriages and the guides can be supplied with a HCP anticorrosion coating.

METAL PROTECTIVE STRIP

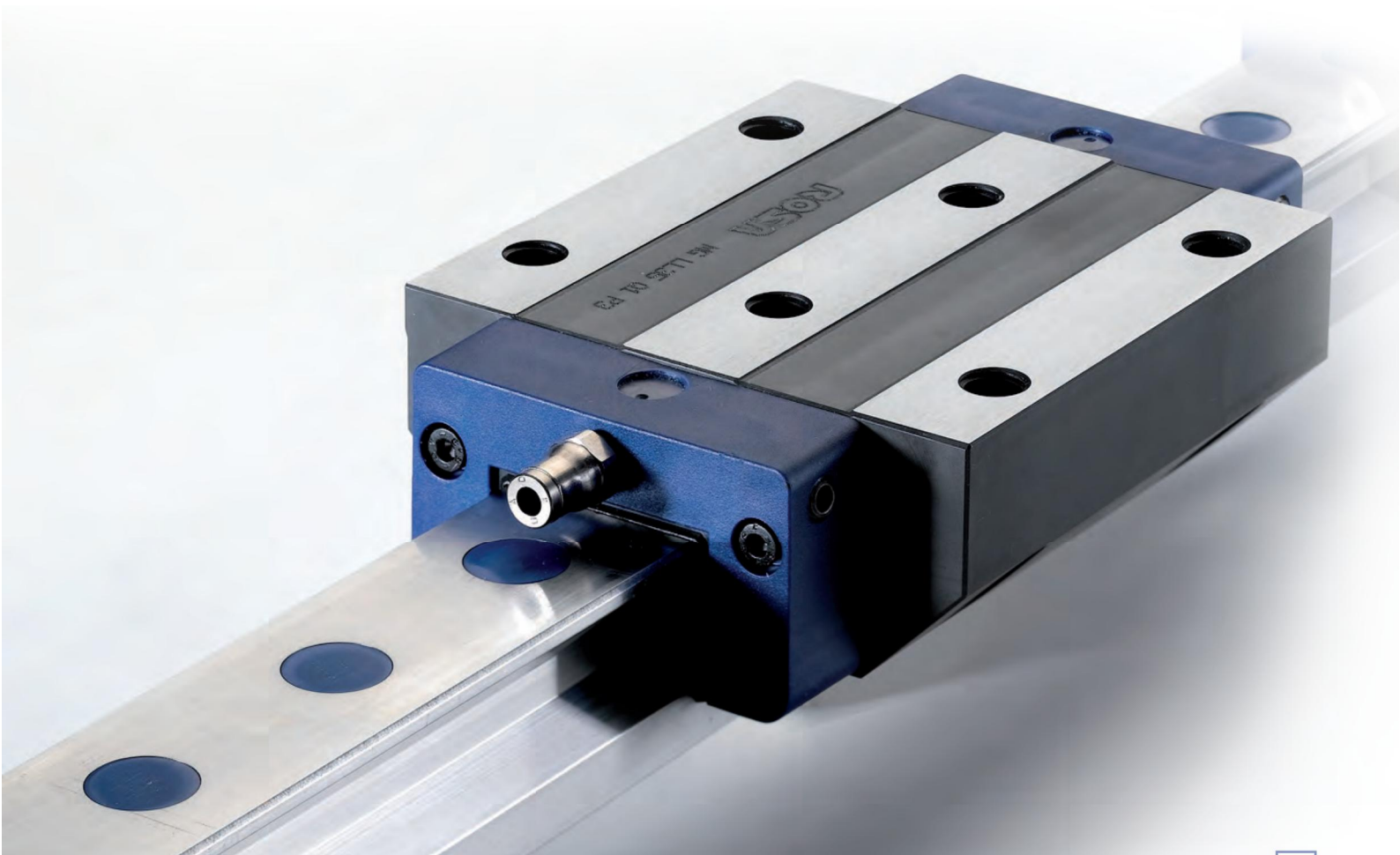

The strip that protects and covers the fastening holes prevents closing caps from being used, thus considerably reducing the overall assembly times and making the wiping operation more effective.



1.1 Product identification codes

MG	35	SC	2	L598	Q1	P2	-
Product type	Rail size (25,35,45,55,65)	Block type	Number of carriages on the rail		Accuracy class (Q0, Q1, Q2, Q3)	Preload (P2, P3)	Extra Coupling Fixing from the Bottom
		SC: narrow-short LC: wide-short SL: narrow-long LL: wide-long					
							Rail length (mm)

Order sheet

Size	<input type="checkbox"/> 25 <input type="checkbox"/> 35 <input type="checkbox"/> 45 <input type="checkbox"/> 55 <input type="checkbox"/> 65
Carriage type	<input type="checkbox"/> LC <input type="checkbox"/> LL <input type="checkbox"/> SC <input type="checkbox"/> SL
Number of carriages on the rail
Set for top lubrication	<input type="checkbox"/> DAL
Rail length mm
L5 (distance of first hole) mm
Joint rails: pieces length mm
Rail screwed from the bottom	<input type="checkbox"/> FB
Accuracy class	<input type="checkbox"/> Q0 <input type="checkbox"/> Q1 <input type="checkbox"/> Q2 <input type="checkbox"/> Q3
Preload class	<input type="checkbox"/> P2 <input type="checkbox"/> P3
Caps type on request	<input type="checkbox"/> TOMG (Brass) <input type="checkbox"/> TAMG (Steel)
Caps number / rail
Additional end seals/wipers	<input type="checkbox"/> TPA
	<input type="checkbox"/> TPNBR
	<input type="checkbox"/> TPVIT
Long-life cartridge lubrication	<input type="checkbox"/> TLL
Lubricant type	<input type="checkbox"/> Grease <input type="checkbox"/> Oil
Complete code:	

Ref. side HIGH

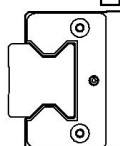

Ref. side LOW

TLL sx

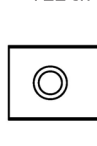

DAL dx

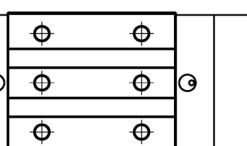

TLL sx

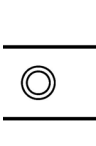

DAL dx



DAL sx

TLL dx

DAL sx

TLL dx

2.

GENERAL TECHNICAL DATA

1. Accuracy classes and tolerances
2. Sliding accuracy
3. Preload classes
4. Allowed acceleration and speed
5. Operating temperatures
6. Construction materials
7. HCP anticorrosion coating
8. Size tables
9. Static and dynamic load capacity. Allowable moments
10. Top lubrication – Size table
11. Guides that can be screwed from the bottom
12. Life
13. Stiffness diagram

2.1 Accuracy classes and tolerances

The MG monorails are available in 4 accuracy classes: Q0, Q1, Q2, and Q3

The tolerances in assembly dimensions are measured from the centre of the block and in the same position of the rail

The sliding accuracy of the carriage over the guide is measured from the centre of the carriage

Tolerances	Accuracy class			
	Q0	Q1	Q2	Q3
Tolerance on H dimension	± 5 µm	± 10 µm	± 20 µm	± 30 µm
Tolerance on A1 dimension	± 5 µm	± 7 µm	± 20 µm	± 20 µm
Variation on H dimension between block of the same rail	3 µm	5 µm	7 µm	15 µm
Variation on A1 dimension between block of the same rail	3 µm	5 µm	7 µm	15 µm
EA: (Extra coupling) maximum dimensions deviation between blocks of two or more parallel rails Δ H	standard 10 µm coupling 5 µm	standard 20 µm coupling 7 µm	standard 40 µm coupling 10 µm	standard 60 µm coupling 25 µm
Parallelism deviation Δ C and Δ A-B	See diagram below			

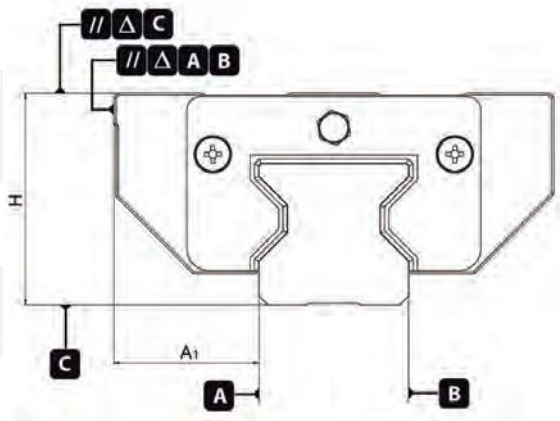

2.2 Sliding accuracy

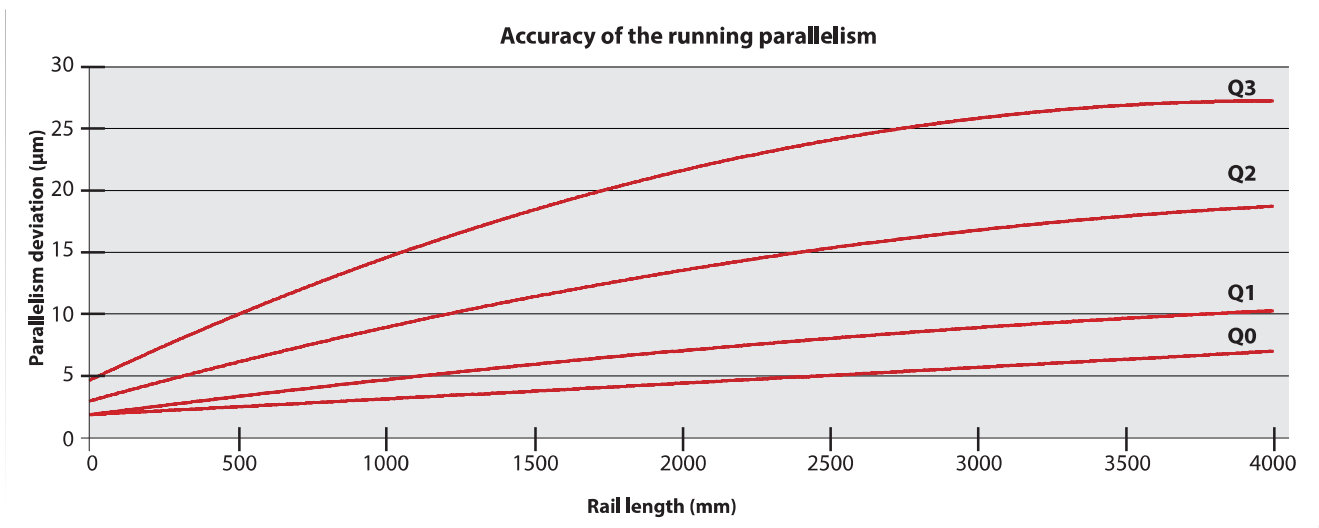

2.3 Preload classes

The preload increases the stiffness of the guide, but influences the life and the resistance to the movement. The two preload classes that are suggested can meet the different application needs.

Preload class	Preload	Accuracy class
P2	0.08 • C	Q0 Q1 Q2 Q3
P3	0.13 • C	Q0 Q1 Q2 Q3

P2 for high stiffness with average-high loads and variable vibrations
P3 for maximum stiffness with high impact stresses or vibrations and high loads/moments

2.4 Allowed acceleration and speed

Speed	$V_{\max} = 3 \text{ m/s}$
Acceleration	$a_{\max} = 50 \text{ m/s}^2$

Higher accelerations and speeds are possible according to preload, load, lubrication and assembly position values. In these cases, it is advisable to contact our engineering department.

2.5 Operating temperatures

Allowable operating temperatures	from -10 °C to + 80 °C
----------------------------------	------------------------

2.6 Construction materials

Carriage:	Hardened alloy steel
Guide:	Hardened steel
Rollers:	Hardened bearing steel
Plastic parts:	POM - PEI GF30 - TPE

2.7 Anticorrosion coating

In case of particular applications, a thin hardened-chromium anticorrosion treatment is available.

Technical features:

- Thickness: 2-4 μm
- Surface with silver or dull black finish
- Untreated rolling elements and threads
- Maximum length of the guide to be treated: 3,5 m. In case of longer lengths ask our technical office
- Available for accuracy classes Q1, Q2 and Q3

2.8 Size tables

LC/LL - block type

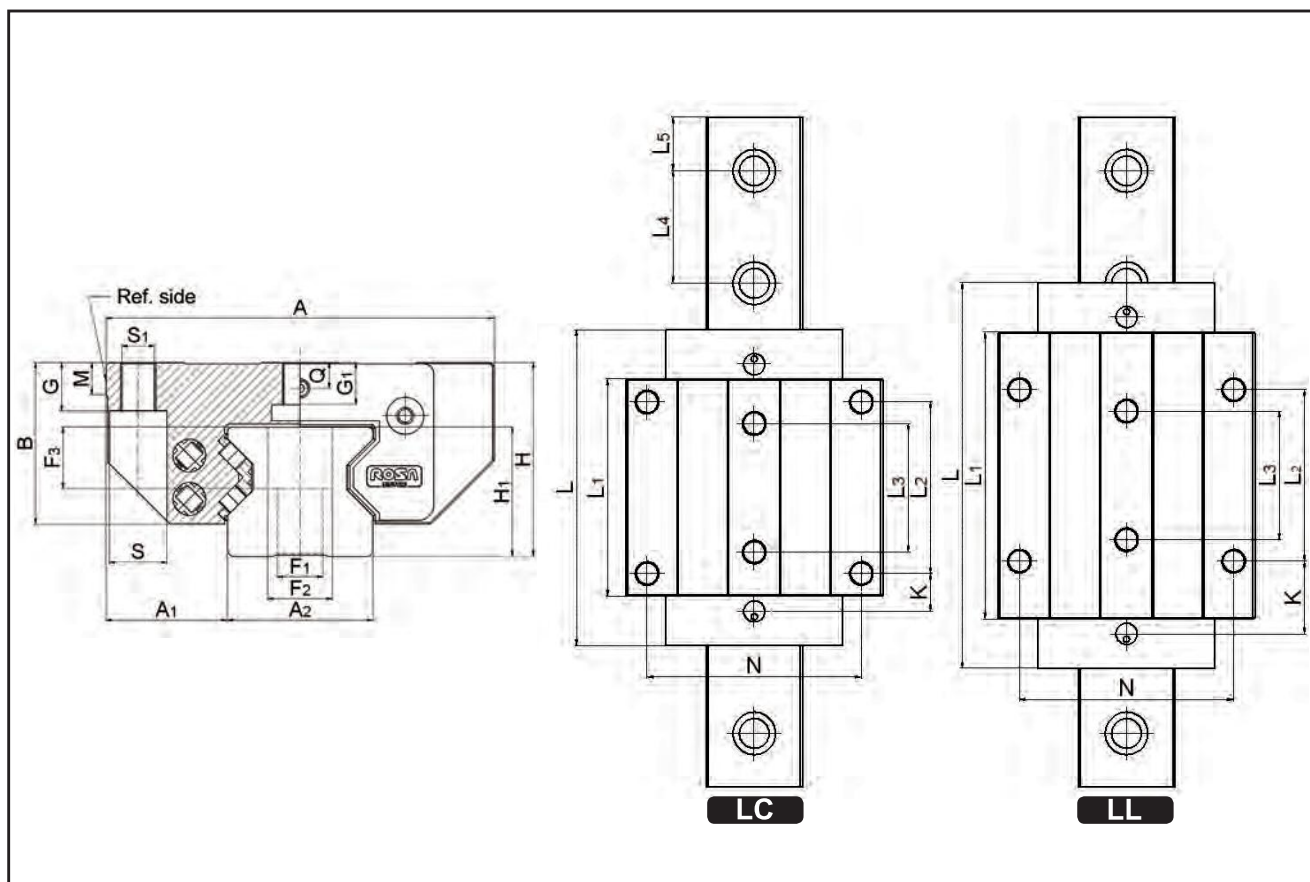

Dimensions (according to the DIN 645/1 standards)

L rail max: 4000 mm

Size	H	A	A ₁	A ₂	H ₁	B	L	L ₁	L ₂	L ₃	L ₄	L ₅	N	S	S ₁	G	G ₁	F ₁	F ₂	F ₃	M	Q	K	Block Weight Kg	Rail Weight Kg/m
25 LC	36	70	23.5	23	24.35	29.5	90.2	62	45	40	30	14	57	11	M8	9	6.5	7	11	11.5	7.5	5.5	14	0.7	3.4
25 LL							109.7	81.5																	
35 LC	48	100	33	34	32	41	119.3	80	62	52	40	19	82	15	M10	12	10	9	15	17	8	7.9	15.5	1.7	6.5
35 LL							142.3	103															27		
45 LC	60	120	37.5	45	39.85	50	147.3	101.3	80	60	52.5	25	100	18	M12	15	12	14	20	19	10	8	17.6	3.3	10.7
45 LL							179.8	133.8															33.9		
55 LC	70	140	43.5	53	47.8	57	173	120	95	70	60	29	116	20	M14	18	13.5	16	24	22	12	9	21.5	5.1	15.2
55 LL							215	162															42.5		
65 LC	90	170	53.5	63	55	78	221,8	159,8	110	82	75	36,5	142	23	M16	22	19,5	18	26	26	15,5	15	36.9	9.3	22.5
65 LL							272,3	210,3															62,15		

SC/SL - block type

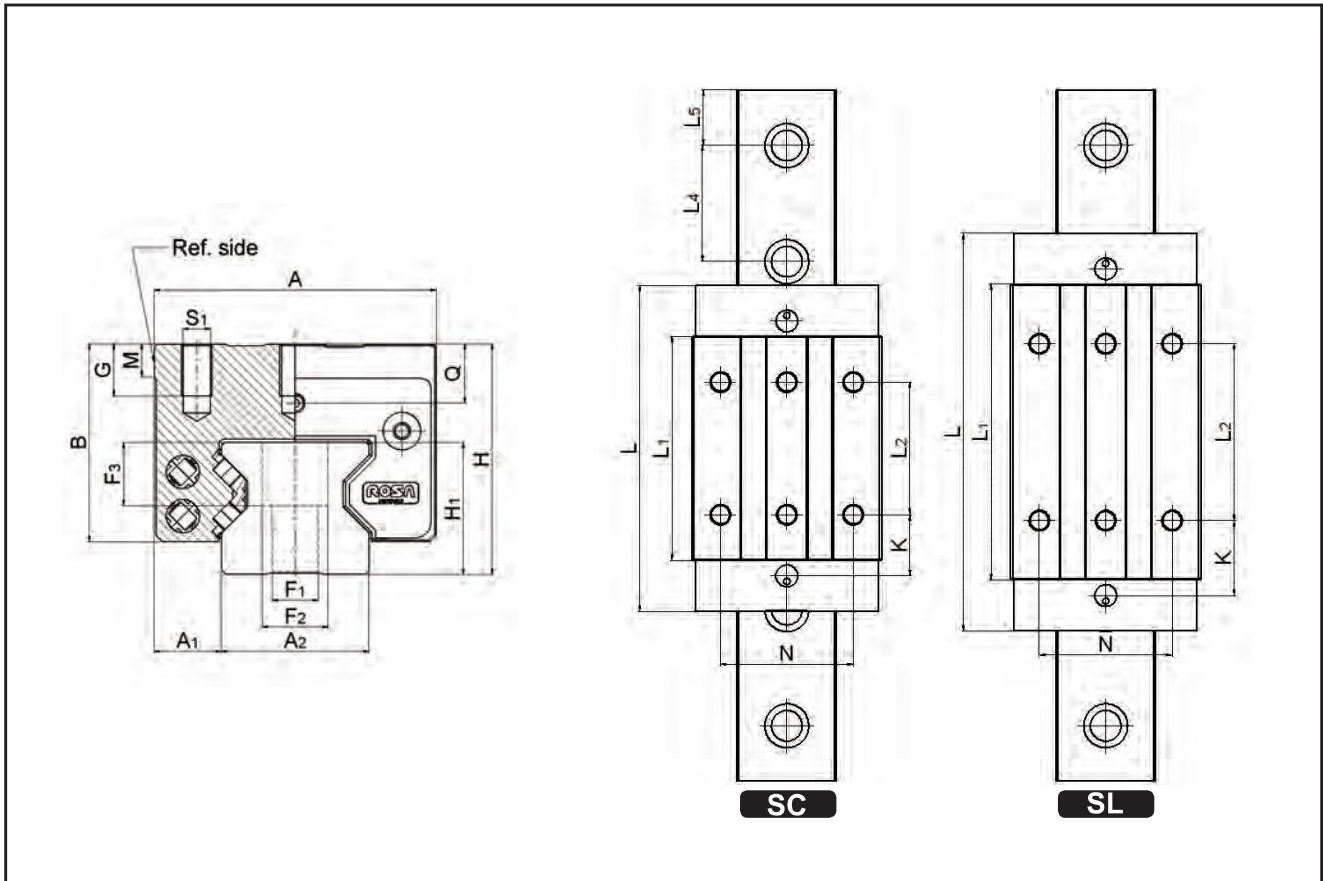

Dimensions (according to the DIN 645/1 standards)

L rail max: 4000 mm

Size	H	A	A ₁	A ₂	H ₁	B	L	L ₁	L ₂	L ₄	L ₅	N	S ₁	G	F ₁	F ₂	F ₃	M	Q	K	Block Weight Kg	Rail Weight Kg/m
25 SC	40	48	12.5	23	24.35	33.5	90.2	62	35	30	14	35	M6	9	7	11	11.5	7.5	9.5	19	0.6	3.4
25 SL							109.7	81.5	50											21.2	0.8	3.4
35 SC	55	70	18	34	32	48	119.3	80	50	40	19	50	M8	12	9	15	17	8	14.9	21.5	1.6	6.5
35 SL							142.3	103	72											22	2	6.5
45 SC	70	86	20.5	45	39.85	60	147.3	101.3	60	52.5	25	60	M10	18	14	20	19	10	18	27.6	3.1	10.7
45 SL							179.8	133.8	80											33.9	4.1	10.7
55 SC	80	100	23.5	53	47.8	67	173	120	75	60	29	75	M12	19	16	24	22	12	19.8	31.5	4.7	15.2
55 SL							215	162	95											42.5	6.2	15.2
65 SC	90	126	31.5	63	55	78	221.8	159.8	70	75	36.5	76	M16	22	18	26	26	15.5	15	51.8	8.5	22.5
65 SL							272.3	210.3	120											57	12.7	22.5

2.9 Static and dynamic load capacity. Allowable moments

LC/LL

SC/SL

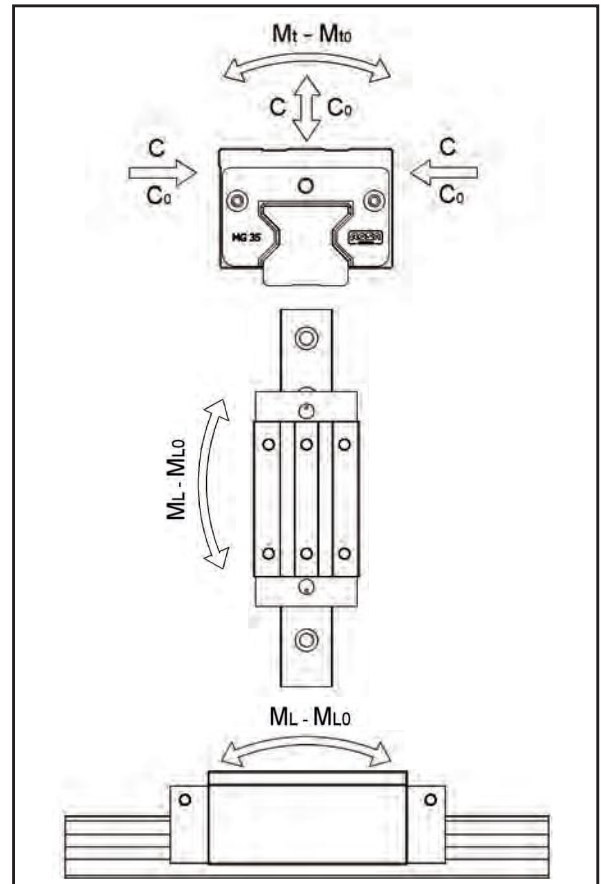
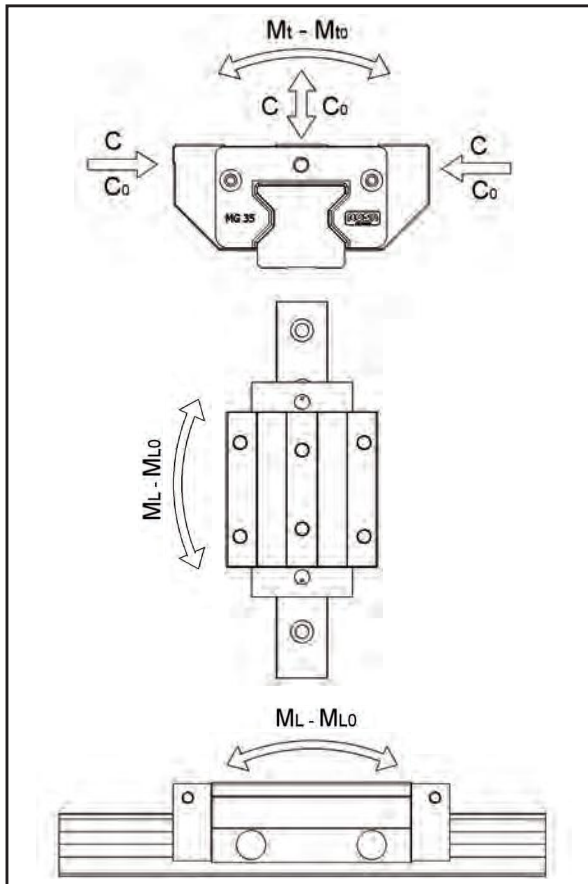

Size	C (N)	C_0 (N)	M_t (Nm)	M_{t0} (Nm)	M_L (Nm)	M_{L0} (Nm)
25 LC / SC	28 700	57 600	431	863	285	570
25 LL / SL	38 900	76 800	583	1150	491	970
35 LC / SC	53 300	99 000	1179	2192	674	1253
35 LL / SL	72 600	136 000	1595	3014	1187	2243
45 LC / SC	95 000	184 000	2617	5070	1538	2979
45 LL / SL	119 500	242 200	3293	6672	2444	4951
55 LC / SC	132 600	256 000	4503	8707	2576	4981
55 LL / SL	176 000	351 000	5977	11915	4470	8910
65 LC / SC	212000	414000	8100	15780	5210	10140
65 LL / SL	276000	579000	10530	22100	8980	11840

2.10 Top lubrication - size table

All carriage types are prepared for top lubrication. SC and SL models are provided with a spacer equipped with O-ring to compensate for the difference in height. Top lubrication must be specified in the order.

Please see the instructions on page 8.

It is not possible to drill the heads after the assembly, as the chips created during this operation may clog the lubrication channels.

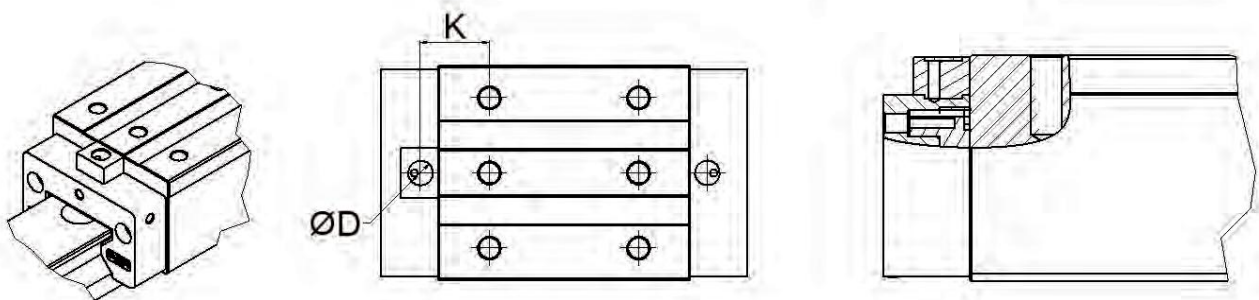

		25	35	45	55	65
K	LC	14	15.5	17.6	21.5	36.90
	LL	23.7	27	33.9	42.5	62.15
	SC	19	21.5	27.6	31.5	51.80
	SL	21.2	22	33.9	42.5	57.00
	Ø D	10	10	10	10	13

2.11 Guides that can be screwed from the bottom

They are available for all accuracy classes

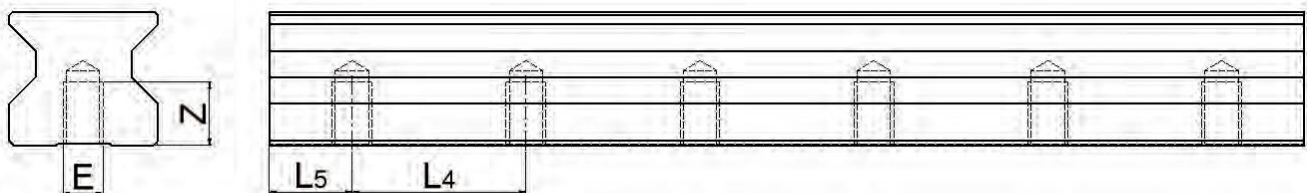

Taglia	25	35	45	55	65
Z	12	15	19	22	25
E	M6	M8	M12	M14	M16

As for L4 and L5 dimensions, see tables on page 12 - 13

2.12 Life

Rosa Sistemi entrusted the machine tool division of the laboratory (WZL) within the Institute of Technology of Aquisgrana with the task of performing the life tests for the new MG monoguide. During the endurance tests, the stiffness of the carriage was measured, as well.

Test bench

The test provides for the simultaneous check of 4 guides, each of which is equipped with a carriage.

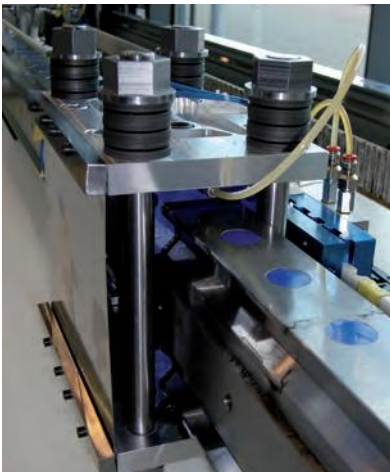

Test conditions

Load coefficient MG35	$C/P = 3$
Load coefficient MG25/45/55	$C/P = 2$
Endurance with $C/P = 3$	3893 km
Endurance with $C/P = 2$	1050 Km
Test speed	120 m/min
Maximum stroke	2000 mm
Acceleration	10 m/s^2
Lubricant	Oil VG-ISO 220

According to the common rules of failure mode evaluation, endurance is considered as to be achieved if the surfaces of the slide ways have no Pitting $> 0.3 \times$ roller diameter.

All tests concerning the MG35 model were interrupted after a stroke equalling 4260 and 4870 km. Despite the long distance in kilometres that was covered, we detected the absence of damage to the slide ways.

Results of the tests

The stiffness values are very important parameters for the accuracy of a machine tool and for calculating the life of the guide system being used. Rosa Sistemi was convinced that the correct measurement of the stiffness in the recirculating linear roller bearing monoguide was a crucial requirement to be certified.

Setting of the test to measure the stiffness

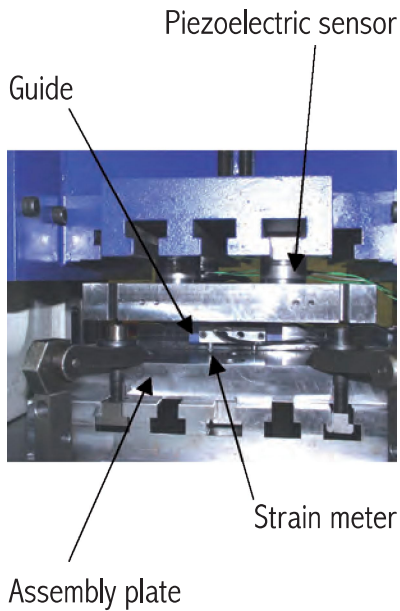

The force is measured by means of a piezoelectric sensor that is installed between the hydraulic cylinder and the assembly plate where the carriage is fastened.

To correctly measure the deformation, an incremental optical ruler was used together with four jumpered strainmeters with a 0.1μ resolution. To have a reliable deformation – force curve, eight measurement cycles are performed for each type of carriage, and then the average values will be calculated.

Measurement results

The measurement of the stiffness in compression and traction conditions according to the above-mentioned modes allowed establishing the deformation - force curves for all types of carriage.

The diagram below shows the curve for MG 35 LC P3.

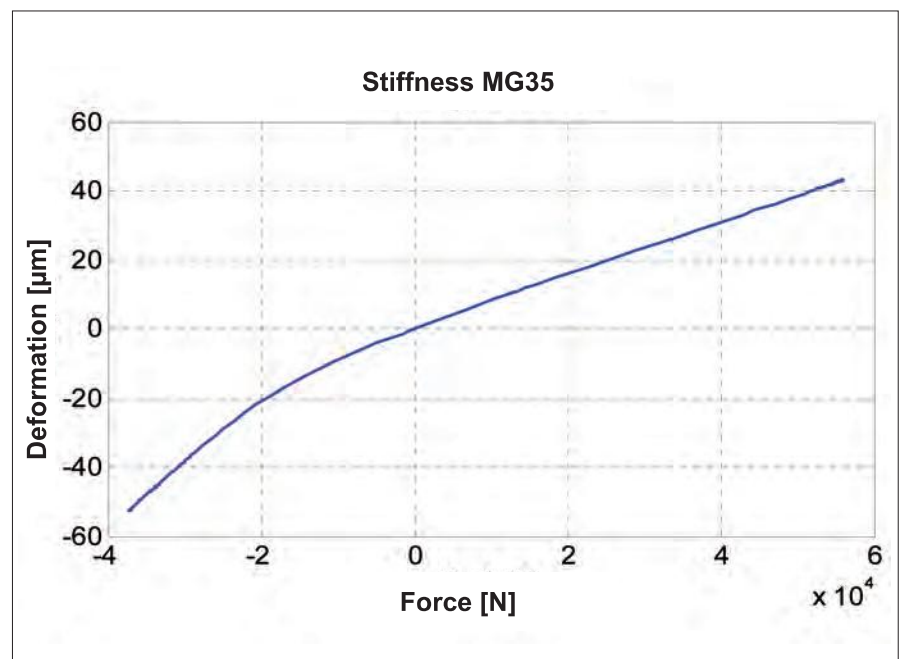

2.13 Stiffness diagram

Stiffness MG25 LC

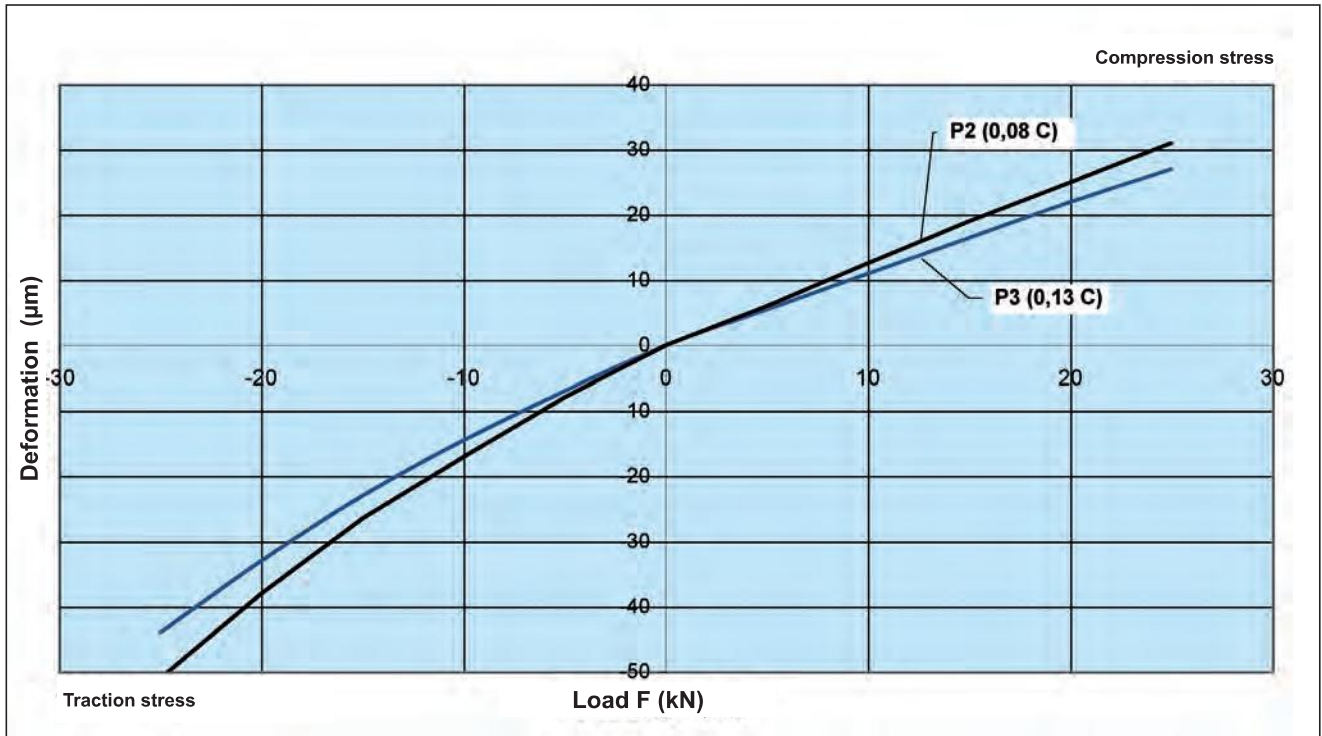

Stiffness MG25 LL

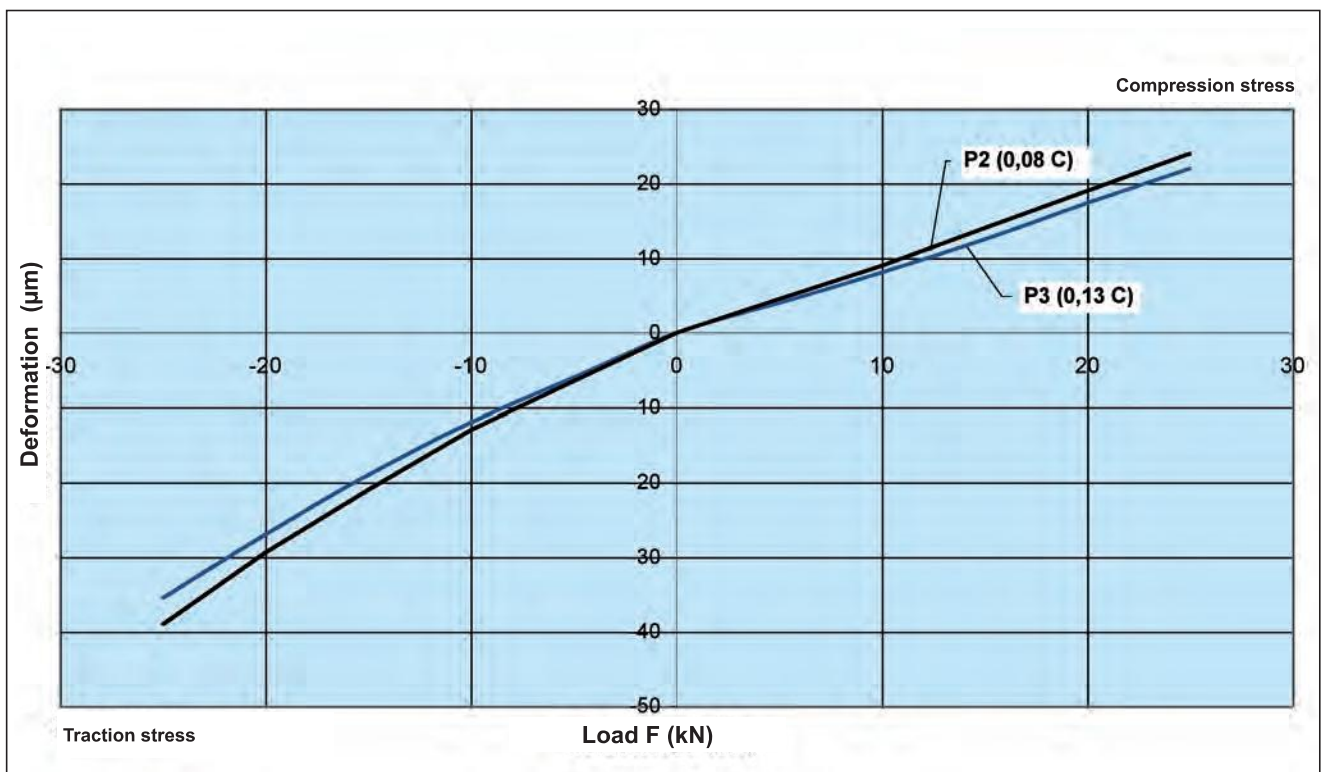

Stiffness MG25 SC

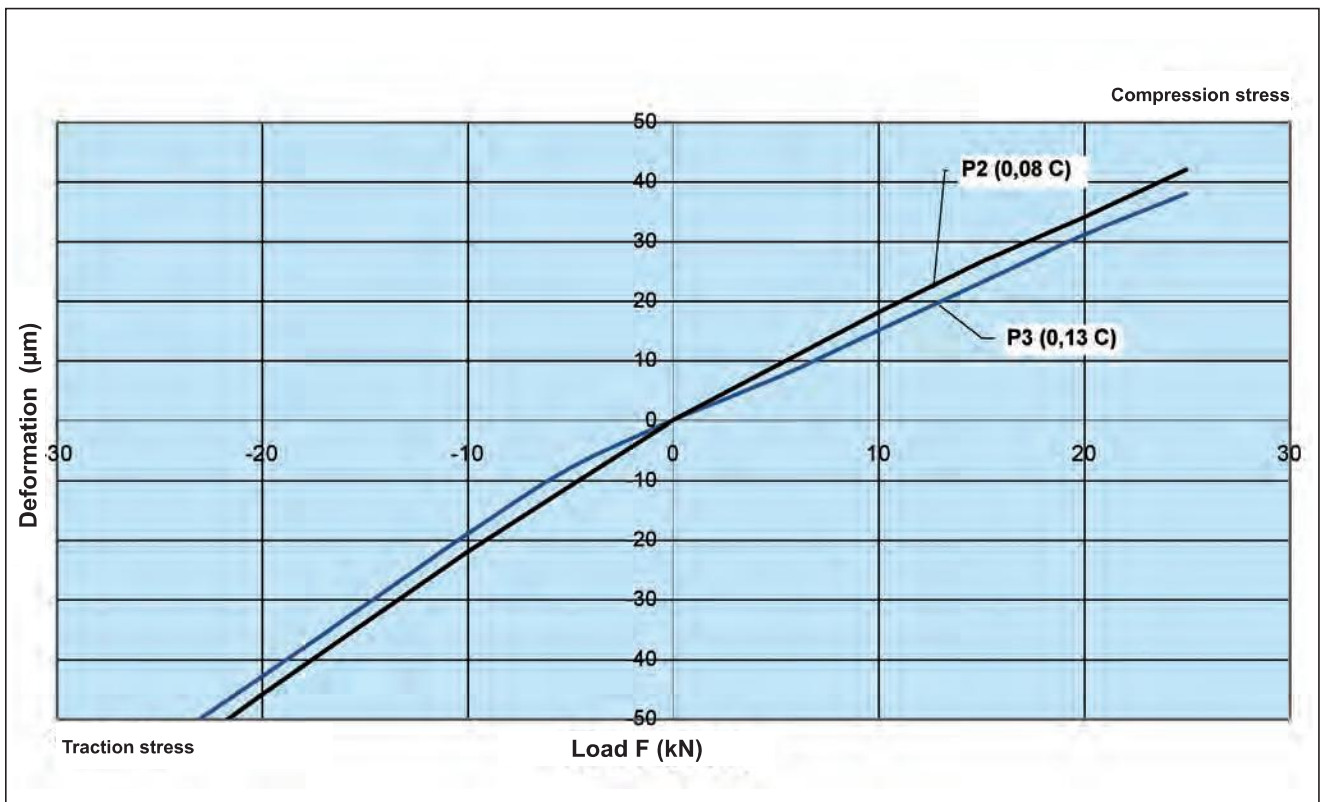

Stiffness MG25 SL

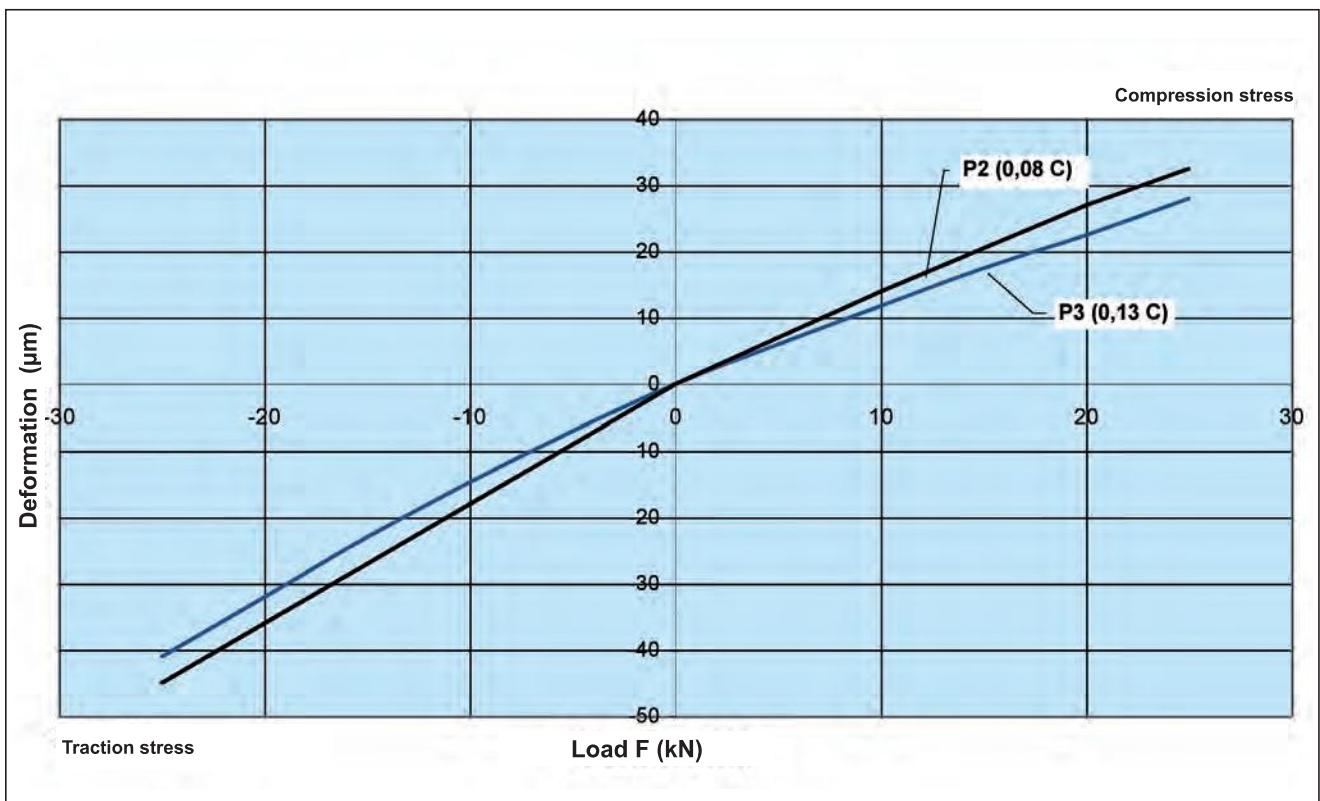

Stiffness MG35 LC

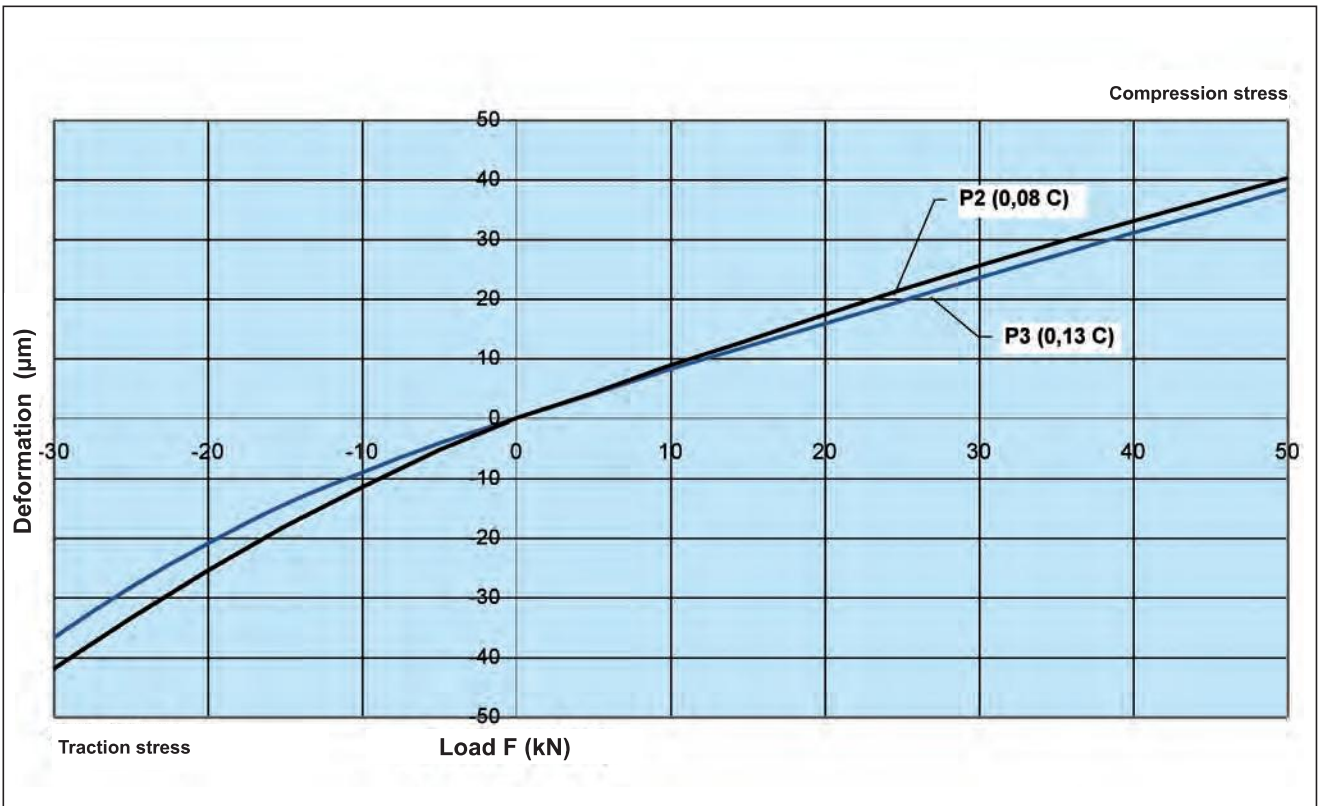

Stiffness MG35 LL

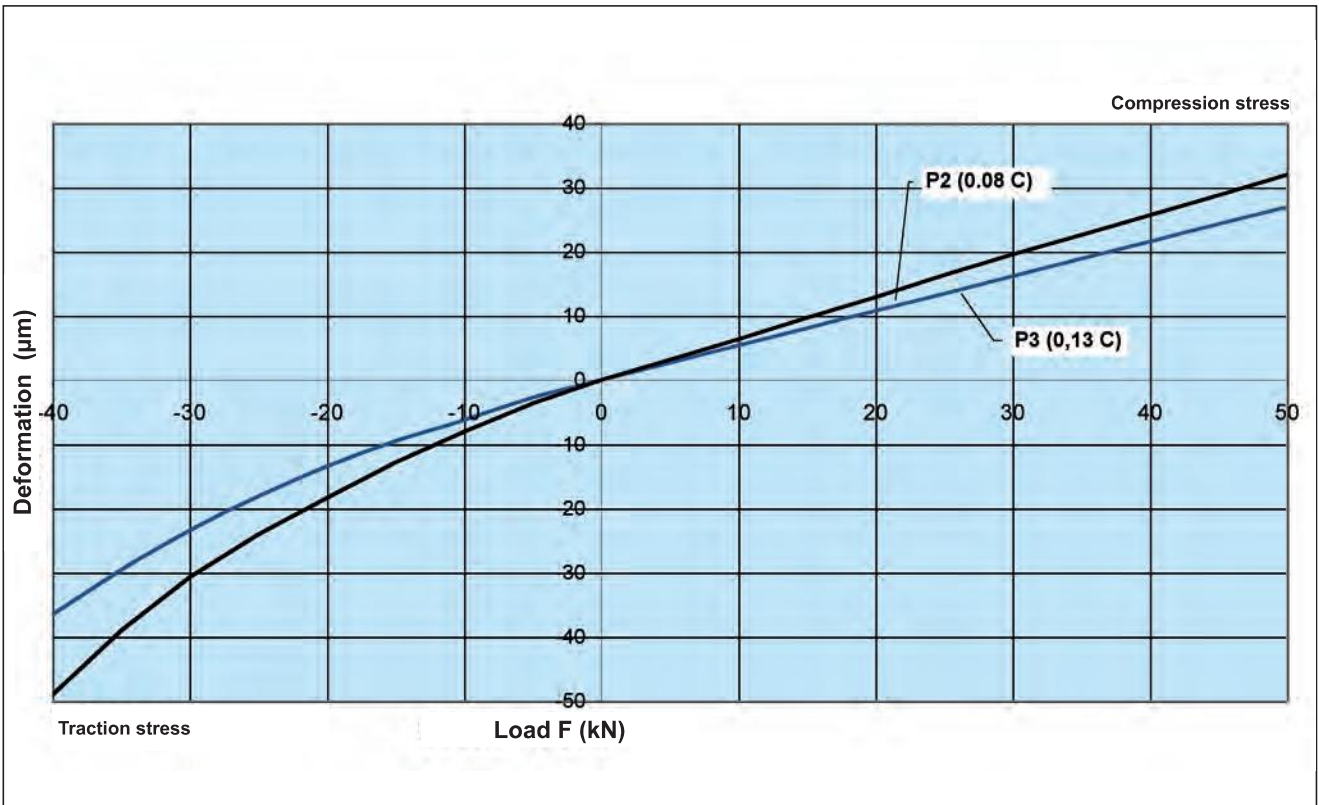

Stiffness MG35 SC

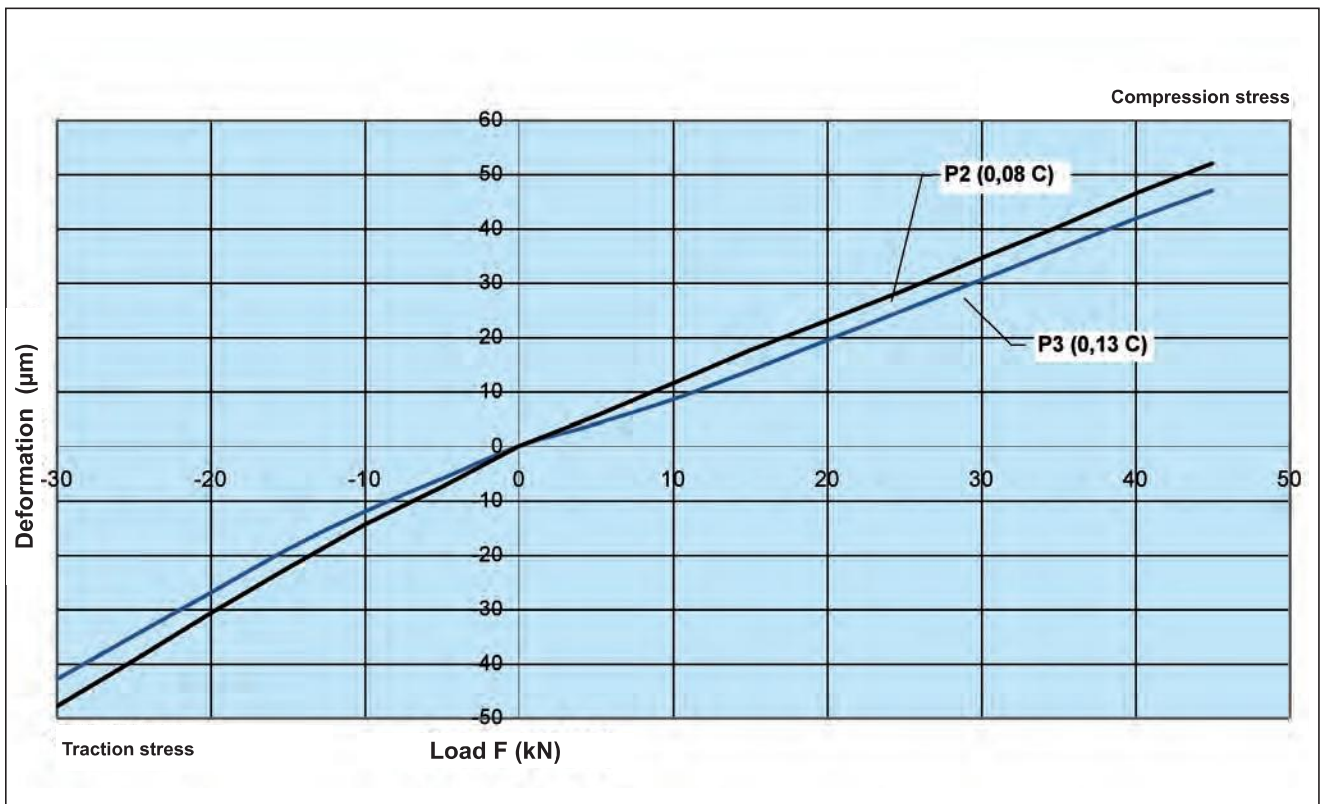

Stiffness MG35 SL

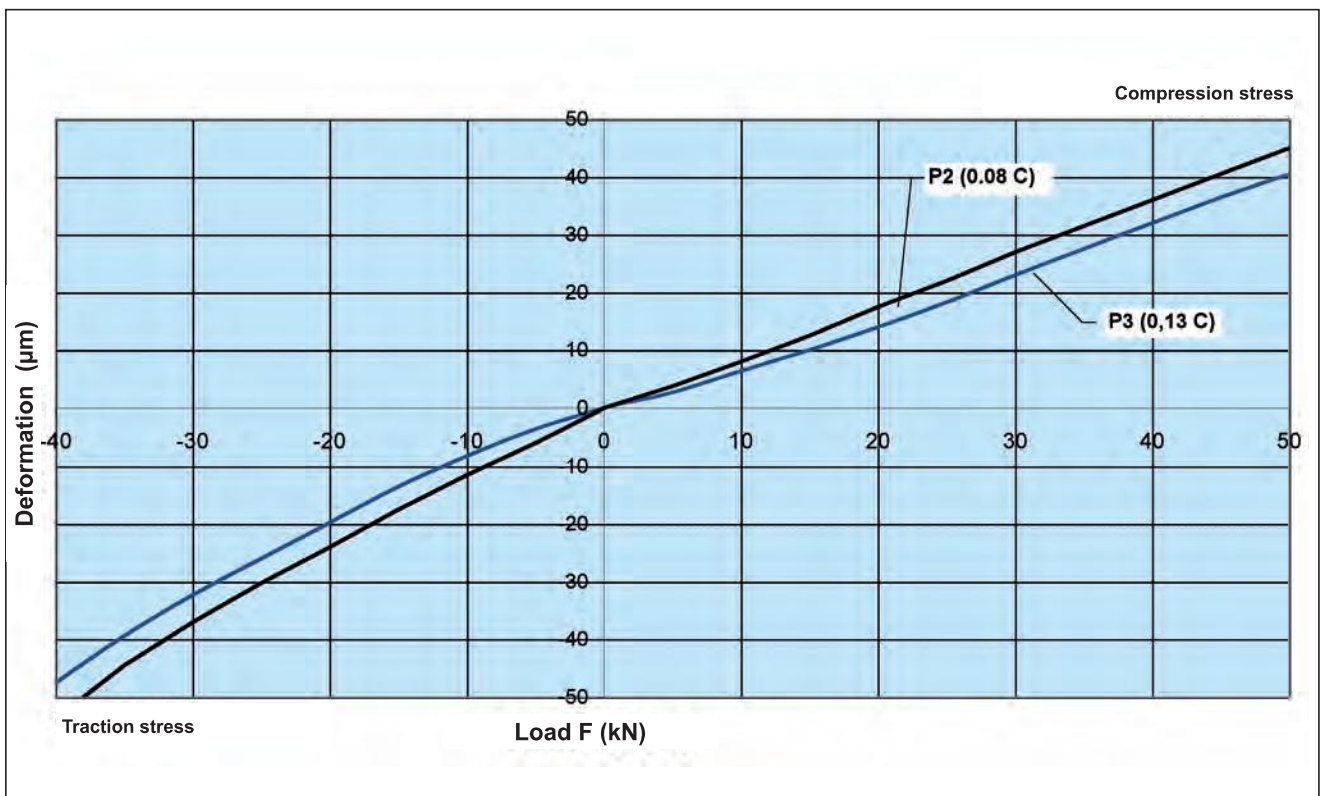

Stiffness MG45 LC

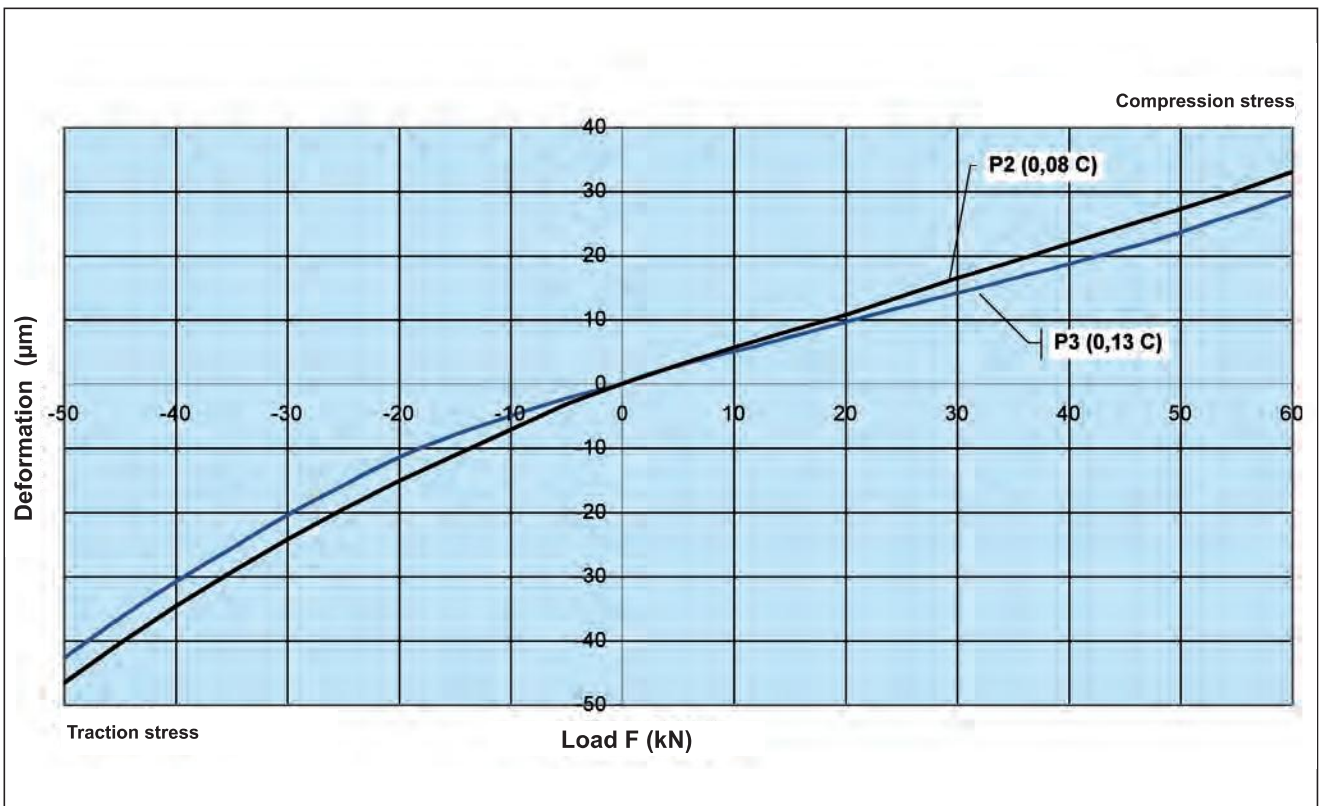

Stiffness MG45 LL

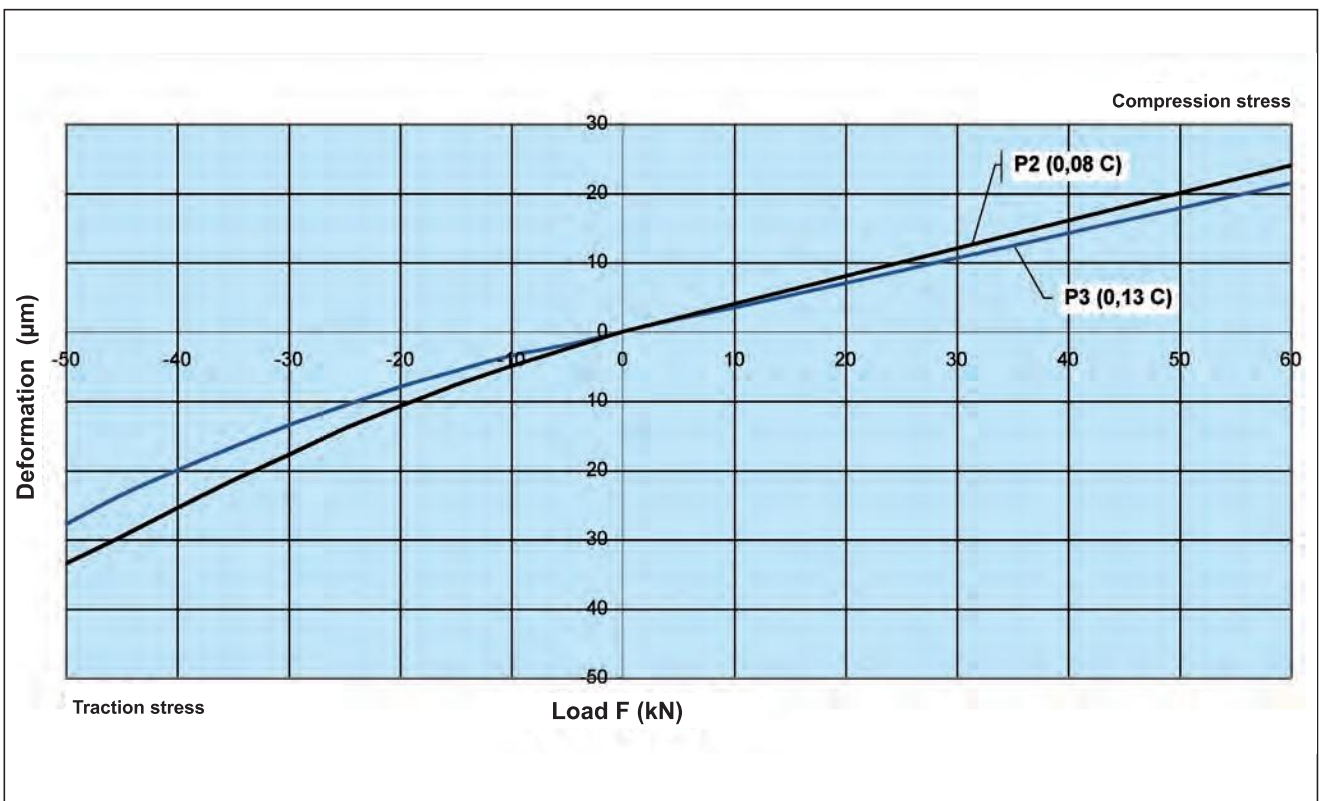

Stiffness MG45 SC

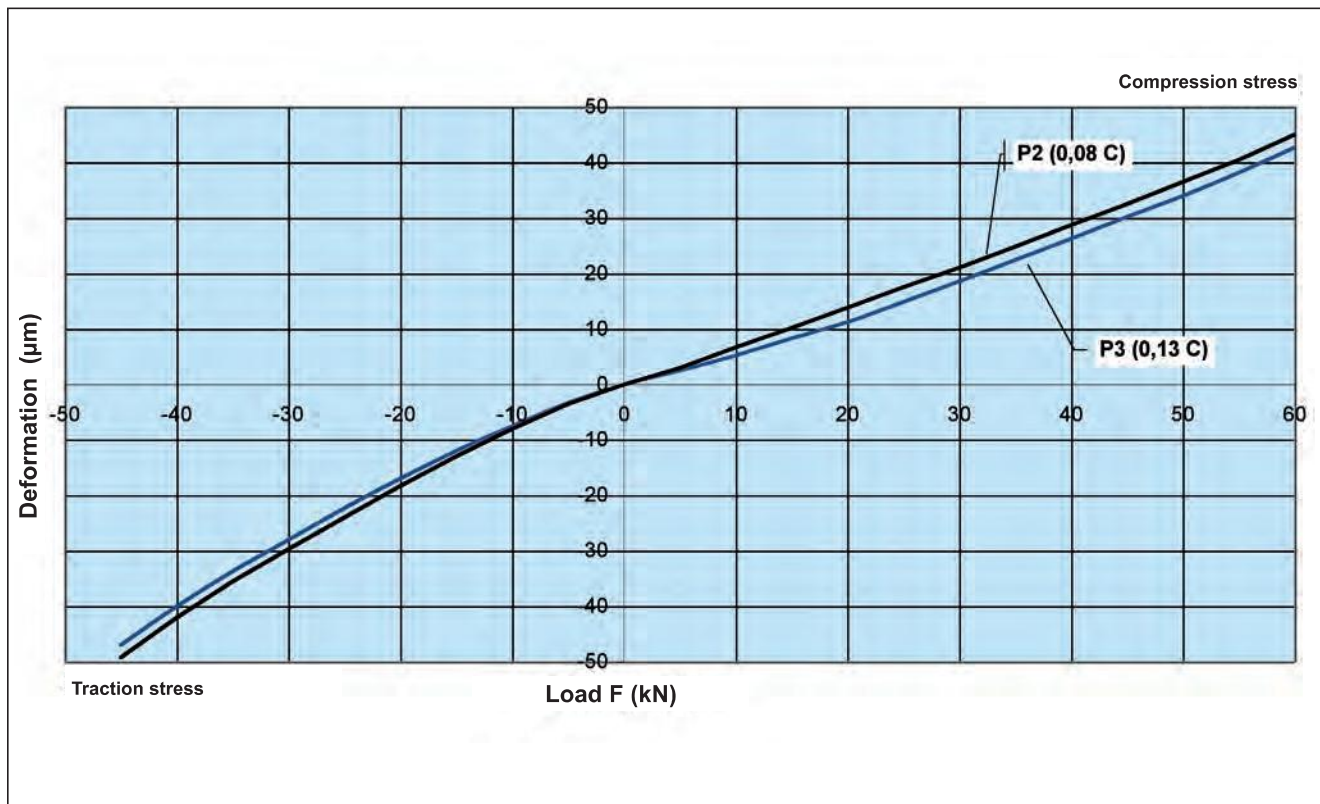

Stiffness MG45 SL

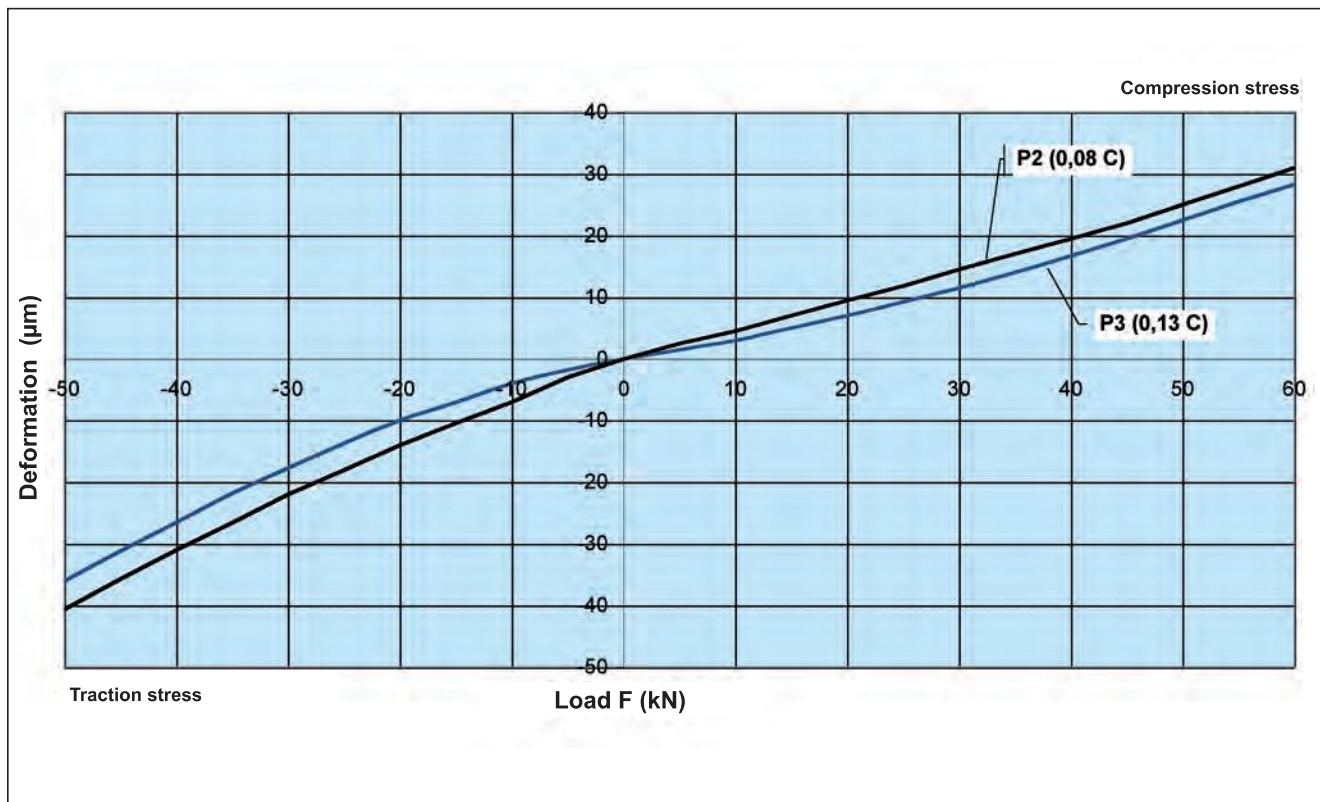

Stiffness MG55 LC

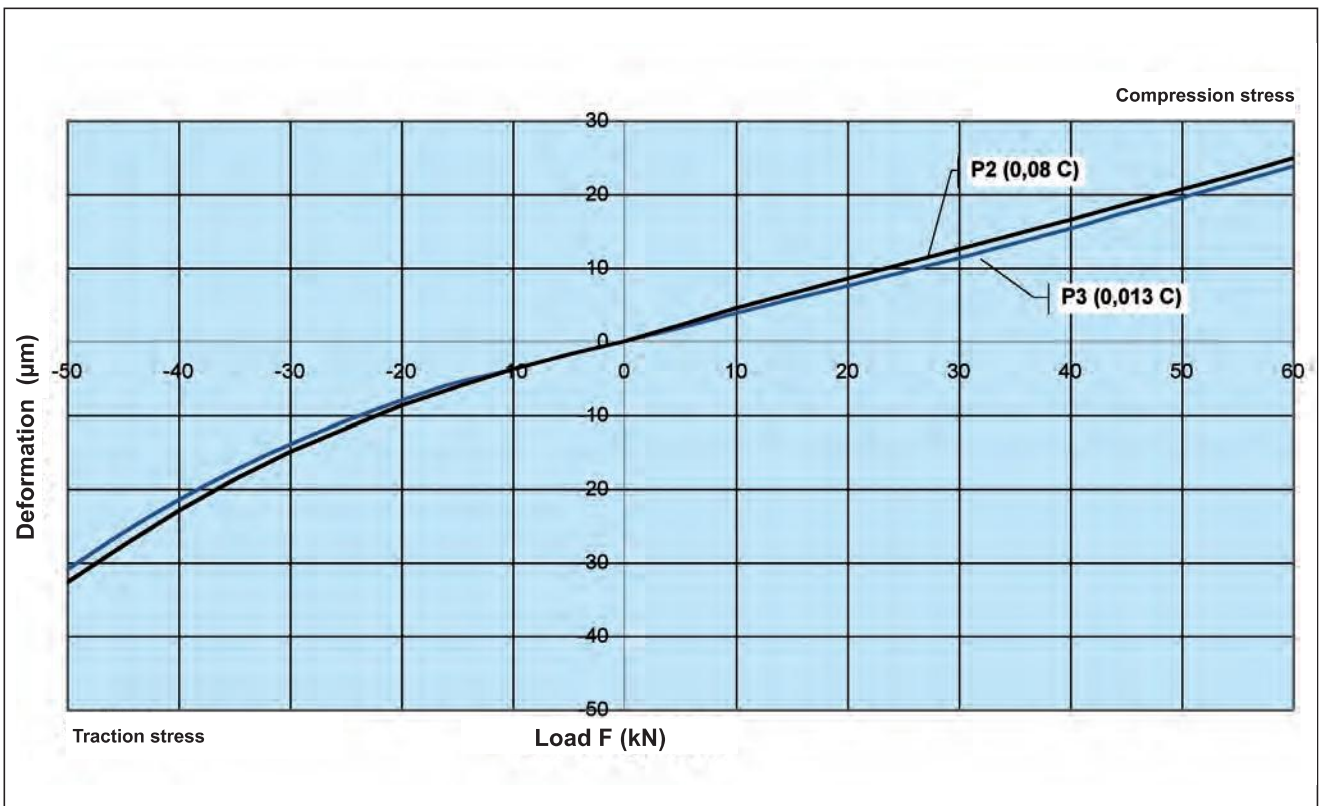

Stiffness MG55 LL

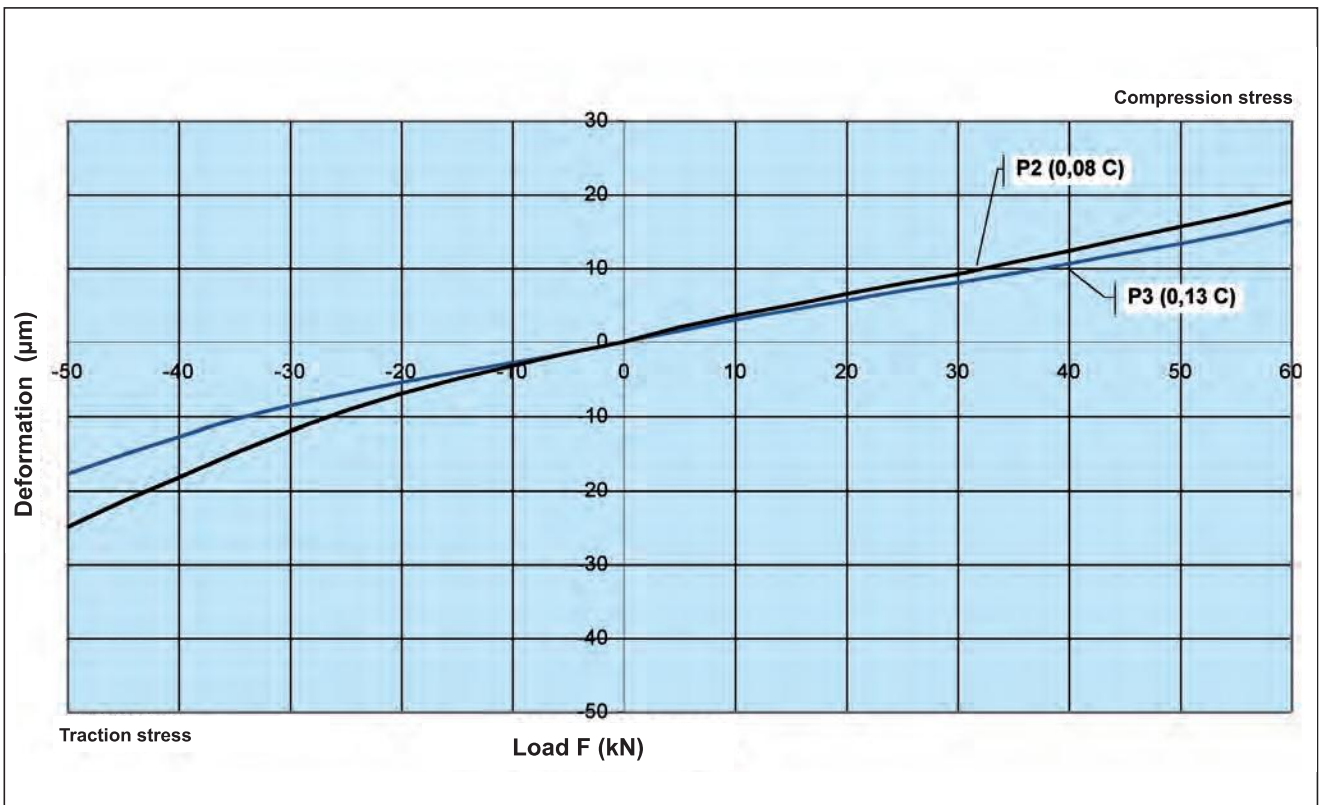

Stiffness MG55 SC

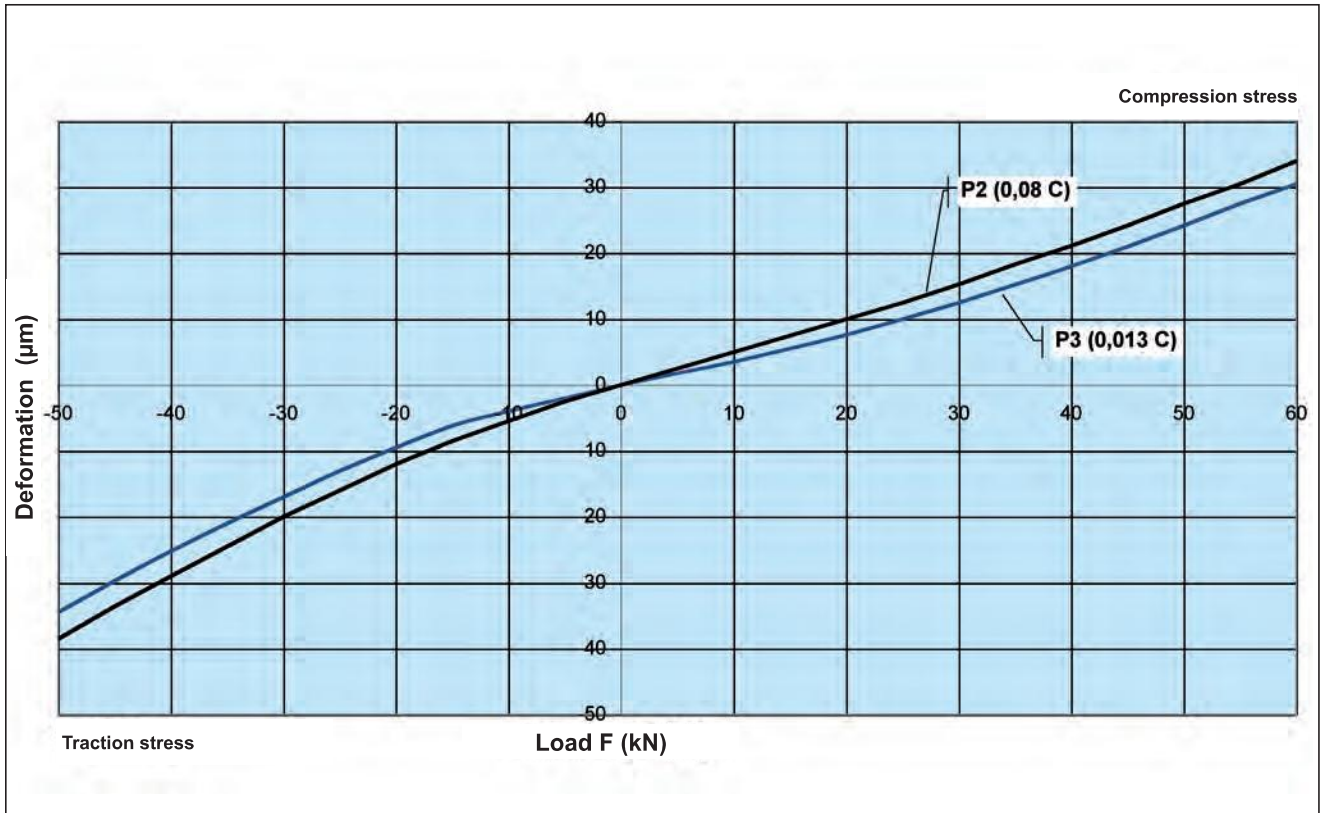

Stiffness MG55 SL

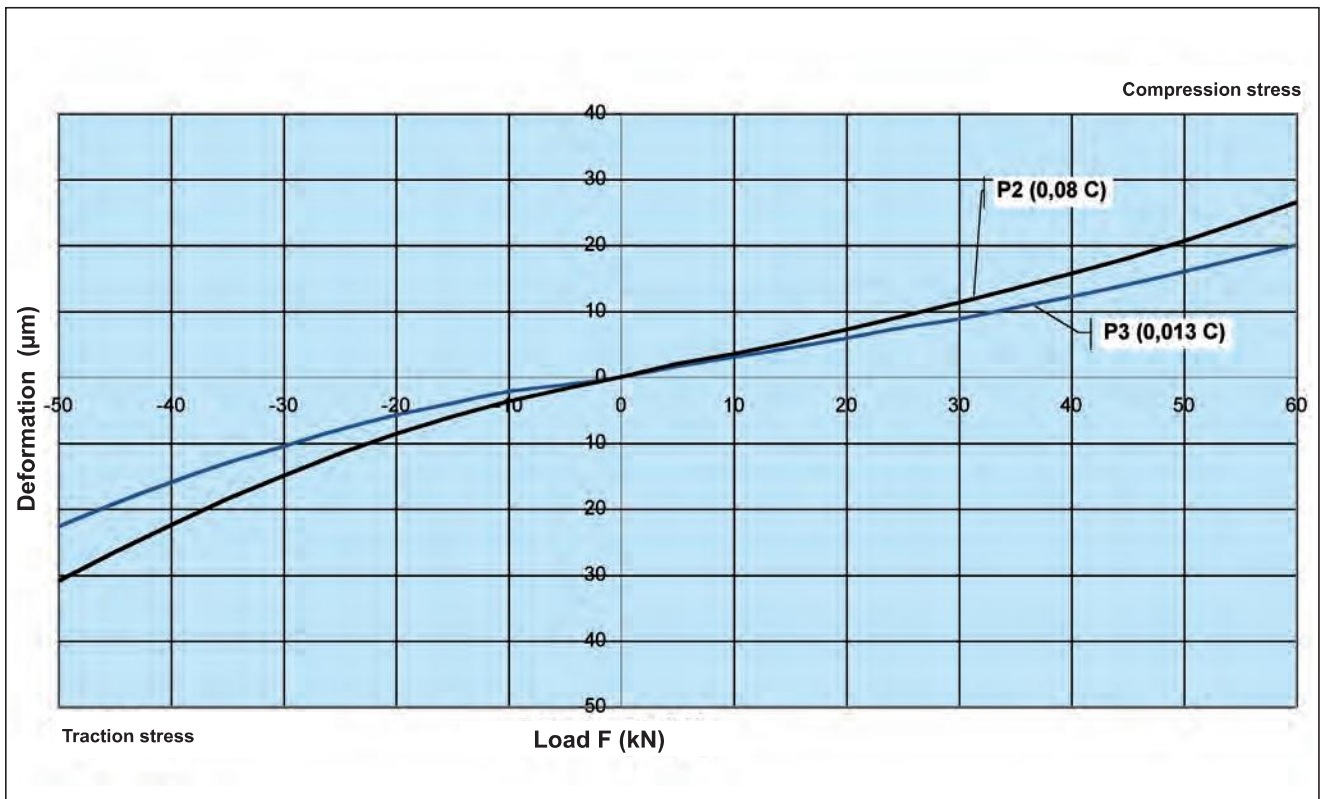

3.

DESIGN OF MG MONOGUIDE

1. Calculation base - Definition of dynamic and static loads and allowable moments
2. Calculation programme to design the monoguide

There are mainly two methods to correctly design the monoguide. The first method is the manual calculation by using the formulas that are listed below. The second method uses a computerized calculation programme that will need the consultancy of Rosa Sistemi's engineers (see page 32) after having detected all necessary data.

3.1 Calculation base - Definition of dynamic and static loads and allowable moments

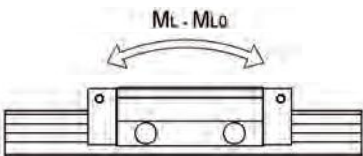
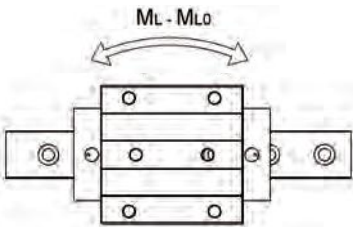
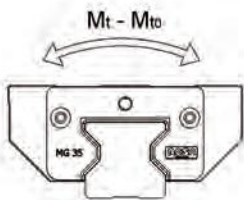
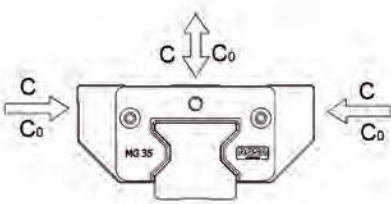

<p>Dynamic load value C</p>	<p>Definition according to the DIN ISO 14728-1 standard</p> <p>Radial load, invariable in size and direction, which can theoretically be absorbed by a linear roller bearing for an expected life of 100 km of covered distance.</p>
<p>Static load value C_0</p>	<p>Definition according to the DIN ISO 14728-2 standard</p> <p>Static load in load direction, which corresponds to a stress of 4000 Mpa, calculated in the centre of the contact point that is more subject to the load between the rolling element and the sliding way.</p>
<p>Torsional moment of dynamic load M_t</p>	<p>Comparison dynamic moment around the longitudinal axis X that causes a load equalling the dynamic load value C.</p>
<p>Moment of dynamic longitudinal load M_L</p>	<p>Comparison dynamic moment around the cross axis Y or the vertical axis Z that causes a load equalling the dynamic load value C.</p>
<p>Torsional moment of static load M_{t0}</p>	<p>Comparison static moment around the longitudinal axis X that causes a load equalling the static load value C_0.</p>
<p>Longitudinal moment of static load M_{L0}</p>	<p>Comparison static moment around the cross axis Y or the vertical axis Z that causes a load equalling the static load value C_0.</p>

To correctly design the recirculating linear roller bearing monoguide, the following instructions must be followed.

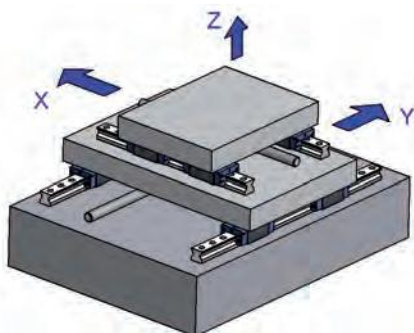

How to establish external forces and moments

The needs for accuracy, quality of surface finishing and of production cycle times influence the design of the monoguide.

In modern mechanical industries, the maximum allowed elastic deformation is strictly connected to the size of the selected guide.

To calculate the life and the deformations, you must detect all external forces and the moments that influence the system according to the relevant value, direction and application point.

When establishing the total equivalent stress, you must take into consideration maximum loads and instant impact stresses, too.

Distribution of forces and moments over the individual carriages

In preload conditions (almost constant stiffness), the force components that influence the carriages (traction, compression and side forces) can be calculated by using well-known mechanics formulas, by taking into consideration the crosswise and longitudinal distance of the carriages.

Equivalent bearing stress

To calculate the life, every partial stress generated by a load will be summarised in the so-called equivalent bearing stress F_r .

An external load, which rests on the carriage with any inclination, will be split up into the components F_y and F_z with the following formula:

$$F_r = \sqrt{F_y^2 + F_z^2}$$

F_r Equivalent bearing stress (N)

F_y Value of the external force over the carriage into the Y direction (N)

F_z Value of the external force over the carriage into the Z direction (N)

How to establish preloads and displacements

To increase the stiffness and the accuracy of a guide system, it is advisable to use preloaded carriages. The selection criteria are listed on page 11.

The forces that influence the carriages cause the deformations that can be quantified by the stiffness diagrams on page 18.

How to calculate the life

The forces that act over the monoguide, the selected preload value, the dynamic load C and the life probability are the factors that influence the relevant life.

Actual load of the equivalent bearing P

To establish the actual load of the equivalent bearing P, you must consider the carriage preload, too.

- F_r Equivalent bearing stress (N)
- F_{pr} Preload force ($F_{pr} = C \cdot P\%$) (N)
- P Equivalent actual load (N)

<p>If the load applied over the carriage is higher than the preload force by 2.9 times, the carriage will have no preload. In this case, the preload force will not influence the relevant life.</p>	<p>With $F_r \geq 2.9 \cdot F_{pr}$ $P = F_r$</p>
<p>If the applied load is lower than 2.9 times compared with the preload force, part of the latter will join the actual load of the equivalent bearing P. In case of limited loads, it is necessary to keep part of the preload, thus assuring the rolling of the rollers and preventing slipping phenomena.</p>	<p>With $F_r < F_{pr} \cdot 2.9$ $P = F_{pr} + 0.66 \cdot F_r$</p>

A continuous variation of the applied load causes the rollers to lift and lower over the sliding way, thus damaging the carriage.

Equivalent dynamic load with different applied load values

When calculating the equivalent dynamic load, a constant force F is assumed for each partial passage lk .

$$P = \sqrt[10]{P_3^3 \cdot \frac{lk1}{100\%} + P_2^3 \cdot \frac{lk2}{100\%} + \dots + P_n^3 \cdot \frac{lkn}{100\%}}$$

- P Equivalent actual load (N)
- P_{1-n} Values of the loads to be found during the performance (N)
- lk_{1-n} Application stroke fraction concerning P_{1-n} (%)

Calculation of the life – life expectancy

The load capacities for the rolling bearings are specified according to the DIN ISO standards, so that the life formula gives a value that can be overcome with a probability of 90%. If it is not sufficient, the life values must be reduced with a factor a_1 according to the following table.

Life expectancy %	90	95	96	97	98	99
a_1	1.00	0.62	0.53	0.44	0.33	0.21

Expected life in metres

$$L = a_1 \cdot \left(\frac{C}{P} \right)^{\frac{10}{3}} \cdot 10^5$$

- L Expected life (m)
- C Dynamic load value (N)
- P Equivalent actual load (N)
- a_1 Life expectancy

If the length of the stroke s and the frequency of the strokes n are constant for the entire life, the following formula can be used to establish the life in working hours.

$$L_h = \frac{L}{2 \cdot s \cdot n \cdot 60} = \frac{L}{60 \cdot v_m}$$

- L_h Expected life (h)
- L Expected life (m)
- s Length of the stroke (m)
- n Frequency of the strokes (min^{-1})
- v_m Average displacement speed (m/min)

Calculation of the static safety coefficient

The equivalent static load P_0 should keep well below the value of the allowed static load C_0 .

The coefficient S is defined as the ratio between the nominal static load C_0 and the equivalent static load P_0 , and quantifies the safety against permanent deformations of the rolling elements and the slide ways.

Basically, as for the deformation of the rolling surfaces, it is the maximum value of the stress, which can also be very short.

Expected life

$$S_0 = \frac{C_0}{P_0}$$

Conditions of use	S_0
Maximum stiffness, great impact stresses and vibrations	≥ 6
High stiffness, variable and average impact stresses, vibrations	≥ 4
Uniform stresses, light vibrations	≥ 3

$$P_0 = |F_y| + |F_z| + C_0 \cdot \frac{|M|}{\frac{r_0}{L_0}}$$

S_0 Static safety coefficient

C_0 Static load value (N)

P_0 Equivalent static load value (N)

F_y, F_z External static forces (N)

M Dynamic load moment in the directions X, Y, Z (Nm)

M_{t0}, M_{L0} Allowable cross or longitudinal static moment in one carriage (Nm)

3.2 Calculation programme to design the monoguide

The calculation mode to design the monoguide that is described in paragraph 3.1 is extremely complex and can be used only for simple applications. For this reason, Rosa Sistemi offers a computerized calculation service to its own Customers to simplify the manual calculation of the formulas.

Results that can be obtained with the calculation programme

- Necessary size / dimension
- Optimal preload
- Elastic displacement of the work point by effect of the applied loads
- Expected life
- Static load safety factor

The elastic displacement calculation takes into consideration the actual non-linear stiffnesses of the individual carriages. The elastic displacements due to thermal expansions and elastic deformations of machine structure are not taken into consideration.

Necessary data for the calculation programme

- Dimensions of all machine axes and items to be processed
- Position of barycentres
- Geometry of the guides with indication of the number of guides and carriages, longitudinal and crosswise centre distances of the carriages
- Position of the axes in the space and of the distances one to the other (distances of the reference points of the adjacent axes)
- Position of transmission elements compared with the corresponding reference point of the axis
- Position of the loads (moments and forces application points)
- Strokes of all axes
- Speed and accelerations of the axes
- With different loads: overall loads with speed, acceleration, stroke and percentage time value, size and direction of the forces and the moments that influence the work point according to each individual applied load.

As an example of the necessary data for a correct design, see the tables and the drawings below.

Data sheet for an X-Y system

Dimensions							
m_1		N	m_2		N	m_3	N
Barycentres							
x_{m1}		mm	y_{m1}		mm	z_{m1}	mm
x_{m2}		mm	y_{m2}		mm	z_{m2}	mm
x_{m3}		mm	y_{m3}		mm	z_{m3}	mm
Geometry of guides/carriages							
l_1		mm	l_2		mm		
b_1		mm	b_2		mm		
Position of the guides							
x_{B1}		mm	y_{B2}		mm	z_{B3}	mm
Position of the transmission							
y_{A1}		mm	z_{A1}		mm		
x_{A2}		mm	z_{A2}		mm		
Force application point							
x_{F1}		mm	y_{F1}		mm	z_{F1}	mm
Stroke							
s_x		mm	s_y		mm		
Acceleration							
a_x		m/s^2	a_y		m/s^2		

Application of forces and acting moments

Nr	Cicles	F_x (N)	F_y (N)	F_z (N)	M_x (Nm)	M_y (Nm)	M_z (Nm)
1							
2							
3							
4							

Working cycle (stroke/time)

Nr	Speed of axis X v (m/min)	Time t (%)	Stroke s (mm)	Speed of axis Y v (m/min)	Time t (%)	Stroke s (mm)
1						
2						
3						
4						

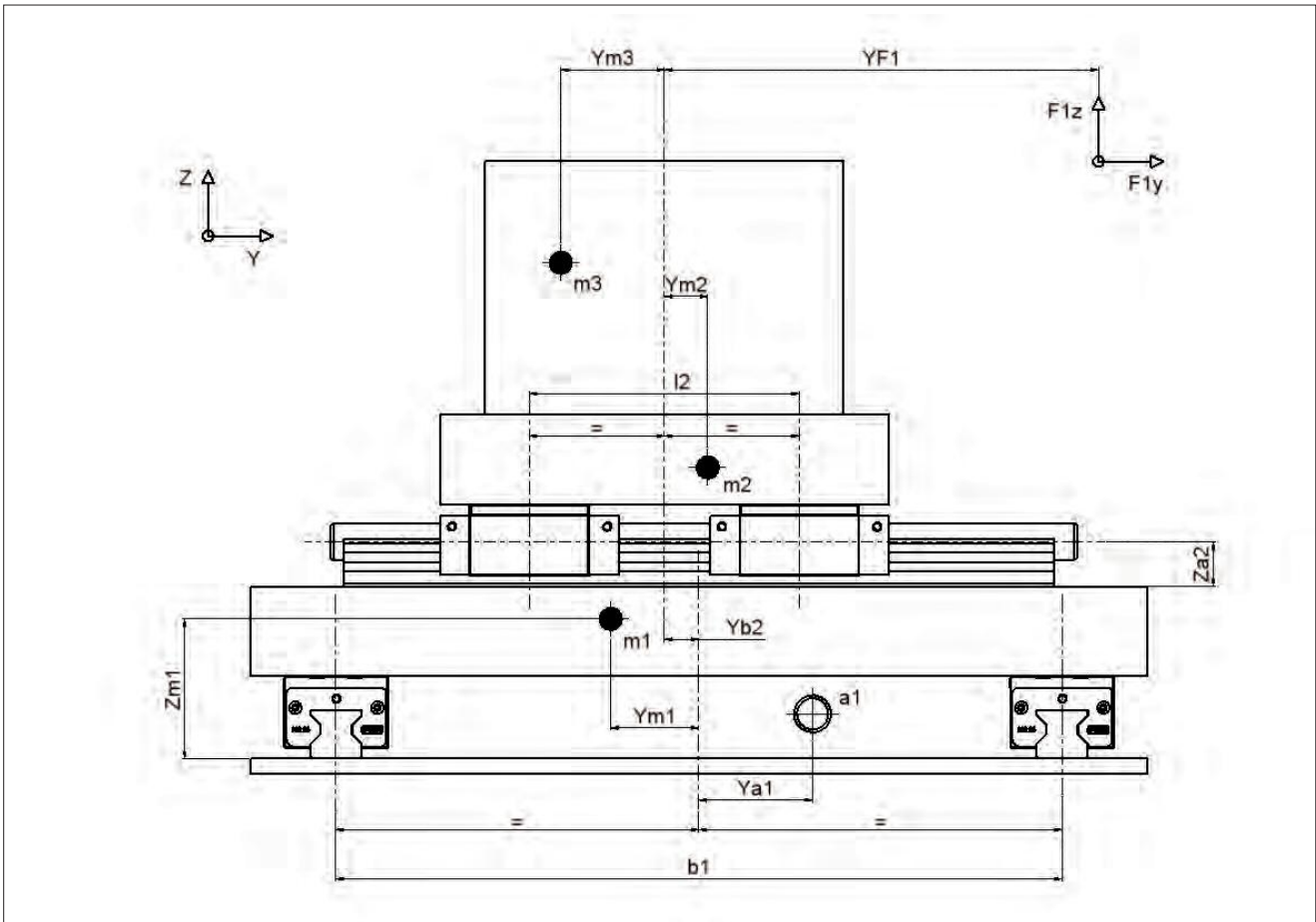
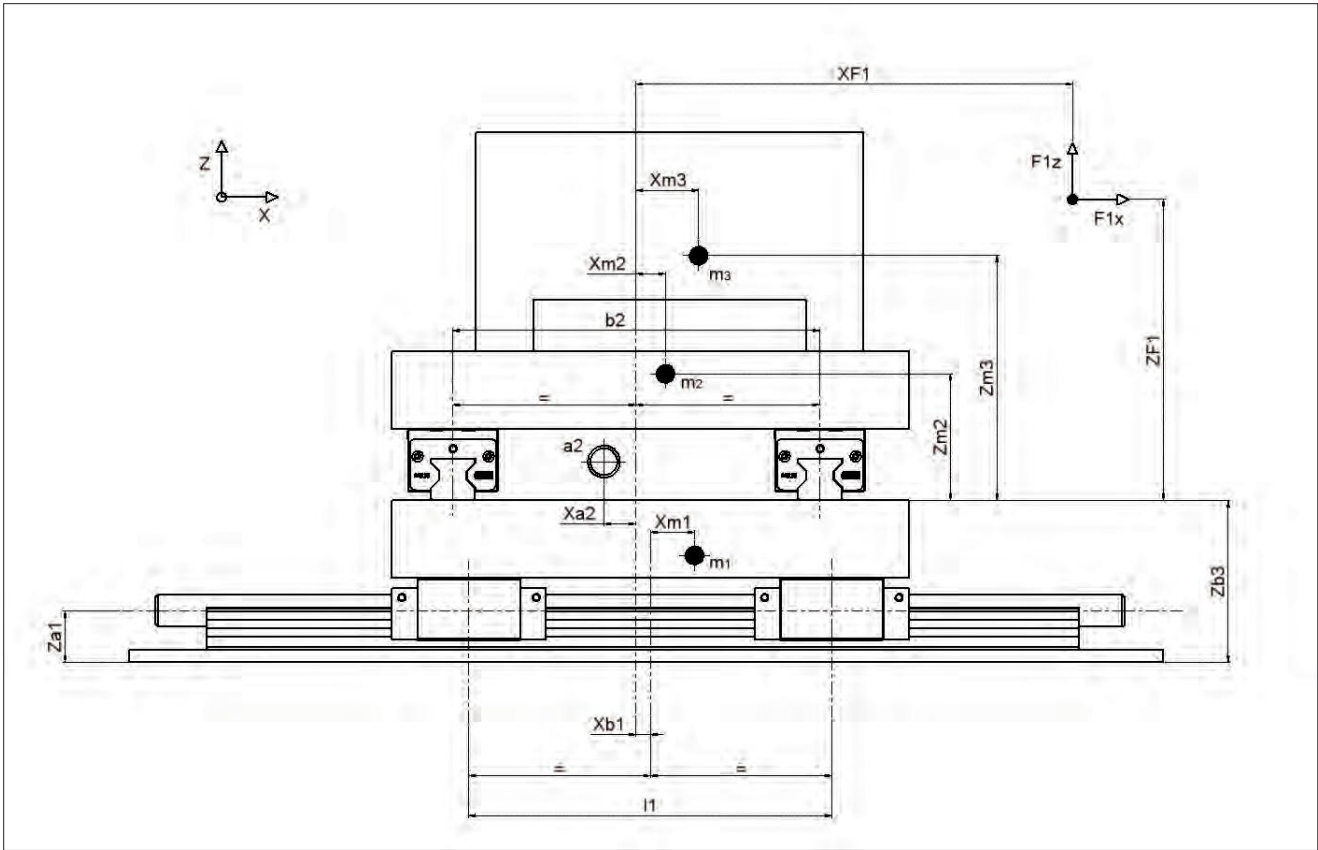

4.

ACCESSORIES

Monoguide accessories



Plastic caps TPMG

They are used to cover the fastening holes of the guide and are included in the standard supply. The caps should not be used in case of metal chips, especially if they are hot; indeed, it is advisable to use the caps with protected axes or in environments that are not very dirty.



Brass caps TOMG

They are used in case of thermal and mechanical stresses, metal chips or rather if an absolutely smooth guide surface is required. They are supplied on demand in the order.



Steel caps TAMG

They are used in case of high thermal or mechanical stresses or in working environments characterised by chip removal.

The covering cap includes a cap and a pressure collar supplied apart. Before installing the caps into the guide holes, both parts must be embedded. In order to correctly fix them, it is advisable to use the specific assembly tool DMT. They are supplied on demand in the order.



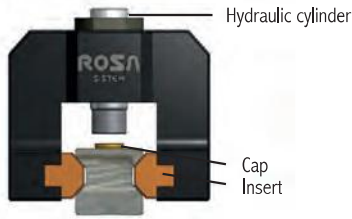

Assembly tool for steel caps DMT

The assembly tool DMT is used to correctly assemble the steel caps that are introduced into the relevant holes. It is supplied on demand in the order.

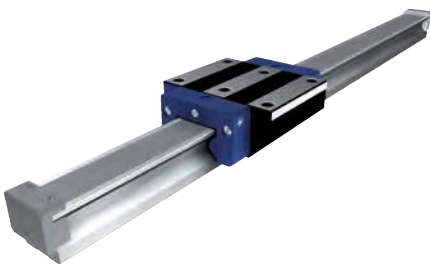

Strip to protect and cover the fastening holes of the guide

The use of the covering strip considerably simplifies the performance of the operations during the fastening of the monoguide.

After having assembled and aligned it on the bedplate of the machine, the protection strip will be introduced into the groove of the guide, and then fastened with two heads at the ends.

Advantages:

- Corrosion-resistant material (stainless steel)
- Particularly tough configuration thanks to the increased thickness
- Anchoring to a special precision groove and fastening to the ends with two closing heads
- Prevents closing caps from being used, thus considerably reducing the general assembly times and makes the wiping action more effective

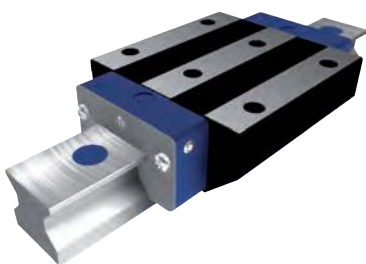

End seal TPA

The stainless steel wiper protects the scraper rings that are built-in in the front heads of the carriage and for possible additional end seals TPNBR/TPVIT.

In particular, it is effective in the presence of hot chips and coarse dirt particles thanks to the minimum clearance between the wiper and the guide.

Dimensions according to the table below.

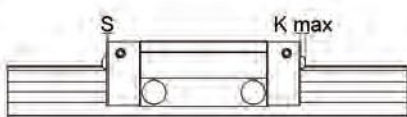

Size	S	Size	K
25	1		2.6
35	1		3.3
45	1.5		4
55	1.5		4.8
65	2		4.8



Additional end seal TPNBR/TPVIT

The end seals TPNBR and TPVIT offer an effective additional protection to the monoguides that work in very dirty environments. They can be directly assembled on the carriages without the need to disassemble the latter.

Features of the NBR version

- Excellent stability in the presence of oil
- Excellent mechanical features
- Working temperature from -30°C to +110°C

Features of the VITON version

- Excellent stability in the presence of aggressive coolants and oils
- Excellent mechanical features
- Working temperature from -30°C to +200°C

The TPNBR/TPVIT end seals can be used together with the metal TPA end seal.

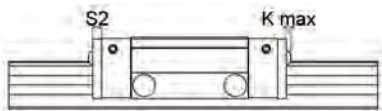

Size	S2	K
25	6	2.6
35	6	3.3
45	6	4
55	6	4.8
65	6	6.2

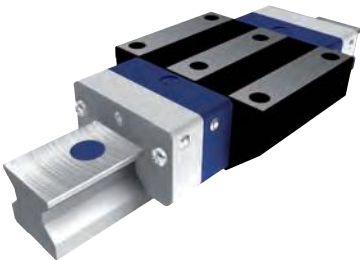

Long-life lubrication cartridge TLL

The cartridge TLL allows a capillary lubrication of the slide ways by using minimum quantities of lubricant. Indeed, by using a special synthetic material, just the necessary quantity of lubricant flows: this way, the re-lubrication time will be extended as much as possible.

It is advisable to use it in dry and clean environments, always in combination with the steel wipers TPA.

- For a correct functionality, it is advisable to use two cartridges TLL for each carriage (one on each side)
- The distribution of the lubricant is assured in all assembly positions
- The cartridges TLL can be recharged
- Use only high-quality mineral oil DIN 51517 CLP or DIN 51524 HLP with ISO VG 220 viscosity
- Lubrication interval up to 5000 km or maximum every 12 months (variable according to the use)
- Reduction of the costs relating to the lubrication system
- Low environmental impact thanks to a minimum consumption of lubricant

The TLL lubrication units should not be used in the presence of lubricating oil-coolants in direct contact with the guides.

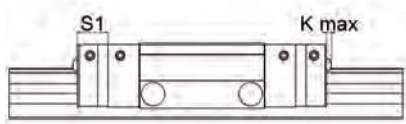

Size	S1	K
25	17	2.6
35	20	3.3
45	23	4
55	27	4.8
65	28	6.2



LinClamp clamping systems

LinClamp clamping systems were designed for static and dynamic locks (emergency).

- Pneumatic compact system (6 bars)
- Active (locking with air) or passive (locking with no air) system
- Excellent locking ability even in case of grease
- Available for all sizes
- Lower costs compared with hydraulic and electric solutions

For further information, call Rosa Sistemi's engineering department.

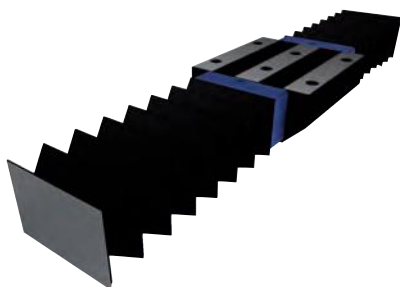

Bellows

The bellows are used as an additional protection against dust and water splashes.

For further information and designs, call Rosa Sistemi's engineering department

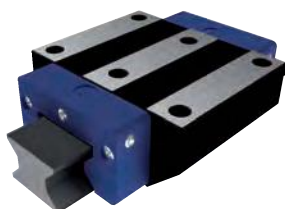

Assembly guide

The plastic-material assembly guide is used to transport the carriage and if it is necessary to remove the latter from the monoguide.

Always leave the assembly guide in the carriage to prevent losing the rollers and as a dust protection.

5.

LUBRICATION

1. Greasing
2. Oiling
3. Lubrication accessories

The front head of the carriage is a particular and innovatory feature of Rosa Sistemi's monoguide. Indeed, each distribution channel is equipped with a check valve that allows the lubricant to be dosed and taken to the slide ways with minimum pulses in any assembly position.

Lubrication

Suitable lubrication assures the correct operation of the guide. Indeed, the lubricant protects against corrosion and polluting agents, thus reducing wear and friction. You can use oil, grease and liquid grease (low viscosity).

Delivery condition

At delivery, the carriages and the guides are protected with high-quality semi-synthetic oil. This protection is sufficient to perform the first assembly. Before the commissioning, you must perform the first lubrication of the carriages according to the following instructions.

Warning

If you use a centralized lubrication system, the adapter and the oil input nipples will not be included in the supply. The standard supply includes one grease nipple per carriage.

Lubrication fitting

The front heads of the carriage are equipped with several lubrication points located in the front and on the sides, and provided with the relevant M6 thread. The aforesaid holes, at delivery, are closed by means of grub screws. On the top of the front head there is a fitting for the additional top lubrication. Upon demand, the carriages will be supplied with specific O-rings and adapters. As for the thicknesses and the dimensions, see paragraph 2.10 on page 15.

Greasing: features and advantages

- Recommended grease type K (fluid grease with density class NLGI 0/1/2, according to the DIN 51825 standard)
- Longer lubrication intervals according to the features of lubricating greases
- Reduction of operation noise
- Increased heating at high speeds
- Increased translation force compared with oiling

Oiling: features and advantages

- Single centralized lubrication system to be used simultaneously for other mechanical elements
- Quick and continuous exchange of lubricant
- Better cleaning of the moving parts
- Decreased heating at high speeds
- Select oil viscosity according to the speed. See the instructions below:

$v < 0.3$ m/s	Lubricating oil ISO-VG 220
$0.3 < v < 1.0$ m/s	Lubricating oil ISO-VG 100
$v > 1.0$ m/s	Lubricating oil ISO-VG 68

5.1 Greasing

Grease / Liquid grease

It is advisable to use the following grease types:

- Grease according to the DIN 51825 standard, type KP2K-20 (high-performance grease based on lithium soap)
- Liquid grease according to the DIN 51826 standard, types: NLGI 00 and NLGI 000

Initial lubrication before the start-up

Immediately after the assembly, the carriages must be lubricated with the quantities that are specified in the table. During the greasing operation, move the carriage for a stroke that at least corresponds to three times its own length.

Quantity cm ³ / carriage	MG25	MG35	MG45	MG55	MG65
LC/SC	1.9	2.9	5.3	8.4	15
LL/SL	2.2	3.7	6.6	10.6	18.9

Following lubrication

The table specifies the correct values.

Quantity cm ³ / carriage	MG25	MG35	MG45	MG55	MG65
LC/SC	0.5	1.2	2.2	3.2	5.9
LL/SL	0.6	1.4	2.6	4	7.4

In case of short stroke (shorter than twice the length L of the carriage), apply a double quantity of lubricant by means of 2 lubrication points (one per each head)

Following lubrication interval

Grease quantity according to the table

Load	MG25	MG35	MG45	MG55	MG65
C/P >8	800 km	500 km	300 km	200 km	100 Km
5 ≤ C/P <8	500 km	300 km	150 km	100 km	50 Km
3 ≤ C/P <5	200 km	150 km	80 km	50 km	25 Km
2 ≤ C/P <3	120 km	80 km	40 km	25 km	15 Km

5.2 Oiling

Oil

It is advisable to use the following oil types:

- Mineral oil according to the DIN 51517 standard, type CLP, or according to the DIN 51524 standard, type HLP
- Viscosity range: from ISO VG 68 to ISO VG 220

Initial lubrication before the start-up

Immediately after the assembly, the carriages must be lubricated with the quantities that are specified in the table; move the carriage for a stroke that at least corresponds to three times its own length.

Oil quantity cm ³ /carriage	MG25	MG35	MG45	MG55	MG65
	0.8	1.0	1.4	1.8	3.6

All carriage types

In case of short stroke (shorter than twice the length L of the carriage), apply a double quantity of lubricant by means of 2 lubrication points (one per each head).

Oil quantity cm ³ /carriage	MG25	MG35	MG45	MG55	MG65
$C/P \geq 8$	400 km	250 km	125 km	100 km	50 Km
cm ³	1.2	1.2	1.2	1.5	1.5
$5 \leq C/P < 8$	250 km	180 km	90 km	60 km	40 Km
cm ³	0.7	1.0	0.9	1.2	1.5
$3 \leq C/P < 5$	100 km	80 km	40 km	30 km	20 Km
cm ³	0.4	0.6	0.45	0.5	0.6
$2 < C/P < 3$	40 km	30 km	20 km	15 km	10 Km
cm ³	0.2	0.25	0.25	0.25	0.3

Minimum quantity of oil allowed by impulse

cm ³ / Impulse	MG25	MG35	MG45	MG55	MG65
horizontal	0.06	0.1	0.1	0.16	0.2
vertical	0.06	0.1	0.1	0.16	0.2
crosswise	0.08	0.15	0.15	0.25	0.3



In case of oiling, M6 holes for the lubrication that are not used in the front head of the carriage must be hermetically sealed.



If you use lubricants other than the specified ones, you must take into consideration the need to reduce the re-lubrication intervals, the reduced performances in terms of strokes performed and the load capacity, as well as the possible chemical interactions between plastics and lubricants.



The lubricants that contain solid particles (graphite or MoS₂) should never be used.



In particular conditions of use, such as dirt, use of lubricating-oil-coolant, vibrations or impact stresses, you must adapt the quantities of lubricant to the real working conditions. Indeed, the quantities of lubricant that are specified in the tables refer to ideal conditions of use.

As for the applications in aseptic and vacuum environments, food industry, etc. please call our engineering department.



A following change from grease to lubricating oil is possible, but you need to connect to the front head of the carriage that was not previously used (as the lubrication channels full of grease may prevent the oil from flowing)



In case of greasing, the lubricant must be replaced no matter how after two years due to grease ageing.

Horizontal and vertical axes on Rosa Ermando SpA grinding machine.



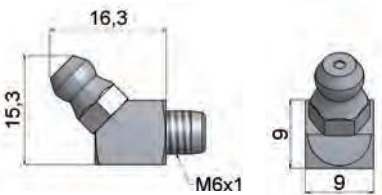
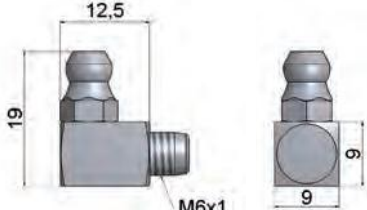

5.3 Lubrication accessories

Grease nipples

	<p>Lubrication nipple (included in all supplies) (INMG)</p>
	<p>45° lubrication nipple (INMG 45)</p>
	<p>90° lubrication nipple (INMG N90)</p>

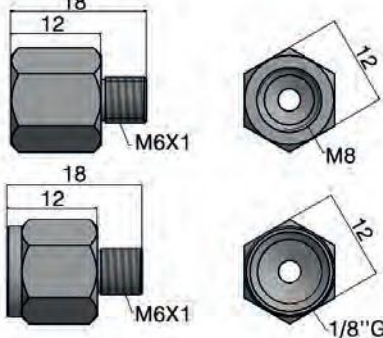
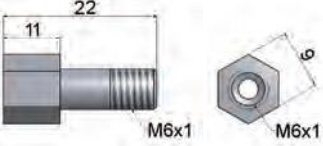
Fittings

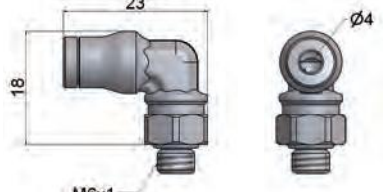
	<p>Reduction fitting (RID M6 M8) (RID M6 1/8 GAS)</p>
	<p>Connecting fitting (RID M6 M6)</p>
	<p>Straight quick coupling (INMG R)</p>
	<p>Adjustable 90° quick coupling (INMG 90)</p>

Quick couplings

NOTE: Max tightening force for cylindrical nipples: 1.5 Nm

6.

INSTALLATION AND ASSEMBLY

1. Fastening instructions
2. Accuracy of assembly surfaces
3. Assembly

6.1 Fastening instructions

Structure of shoulder surfaces

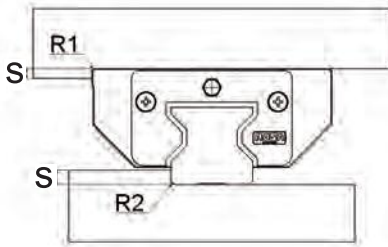

Size	Measures (mm)		
	s	R1	R2
25	5	0,8	0,8
35	6	0,8	0,8
45	8	0,8	0,8
55	10	1,2	1,0
65	10	1,5	1,5

Installation/Fastening screws

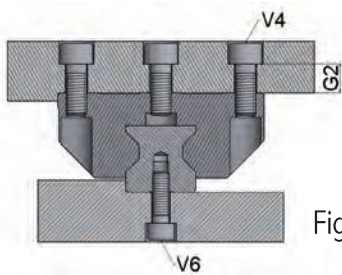

Fig.1

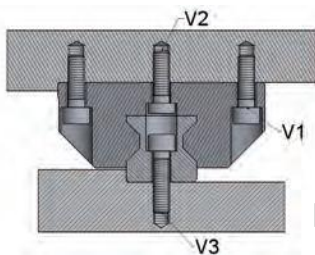

Fig.2

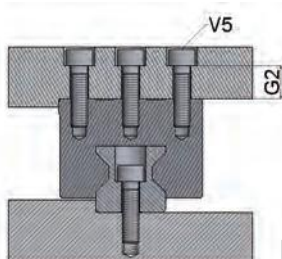

Fig.3

To assure maximum stiffness to the carriage (according to the diagrams on page 18-25), it is absolutely necessary to use all fastening holes.

The carriages can be fastened in two ways:

- Use of threaded holes as shown in fig.1 – fig.3. This method is preferable, as it leads to a stiffer fastening as the thread allows using a screw with a bigger diameter.
- Use of the pass-through holes as in fig.2. In this case, as far as the central fastening holes are concerned, you must use specific socket-head screws according to the DIN 6912 standard.

In case of considerable loads, suitably check the fastening of the guide to the bedplate.

Size	G2 (min)	Dimension of the screws for the carriages			
		V1	V2	V4	V5
		ISO 4762	ISO 6912	ISO 4762	ISO 4762
		4 pieces	2 pieces	6 pieces	6 pieces
25	10	M6x20	M6x16	M8x20	M6x18
35	13	M8x25	M8x20	M10x25	M8x25
45	14	M10x30	M10x25	M12x30	M10x30
55	20	M12x40	M12x30	M14x40	M12x35
65	25	M14x45	M14x35	M16x45	M16x40
		Dimension of the screws for the monoguides			
				V3	V6
25				M6x30	M6x20
35				M8x35	M8x25
45				M12x45	M12x30
55				M14x50	M14x40
65				M16x60	M16x45

Allowable side force when there is no shoulder

If no shoulder surface is provided for, the reference values for the maximum allowable side forces can be established with the help of the following table. The aforesaid values depend on the capacity of the dynamic load C, the type of fastening being used and the resistance class of the screws.

Resistance class	Allowable side force (N) on the carriage without shoulder (Value with static friction coefficient $\mu=0,125$)					
	M6	M8	M10	M12	M14	M16
	6 screws	6 screws	6 screws	6 screws	6 screws	6 screws
8.8	4400	8100	13000	19000	26000	35800
12.9	7500	13800	21900	32000	44000	60400
Resistance class	Allowable side force (N) on the guide without shoulder (exercised by a carriage on the guide)					
8.8	3400	6200		13900	20000	29800
12.9	5700	10600		23500	33700	50400

Recommended tightening torques

Resistance class	Tightening torque (Nm) For fastening screws DIN 912 / ISO 4762 Friction coefficient $\mu=0,125$					
	M6	M8	M10	M12	M14	M16
8.8	10	24	48	83	130	200
12.9	16	40	81	135	215	265



- Follow the instructions of the screw manufacturer: they will always be binding
- The screws according to the DIN 912 standard, with socket head, must be tightened in compliance with the instructions for class 8.8
- If you use lubricating greases, the friction coefficient μ can be reduced even to half; therefore, the tightening torques must be proportionally reduced.
- If you lubricate the fastening screws of the guides with grease and tighten them with a dynamometric wrench, you will obtain a more uniform tightening force, and thus a clear improvement of the sliding accuracy.

6.2 Accuracy of assembly surfaces

Maximum allowable deviation in height

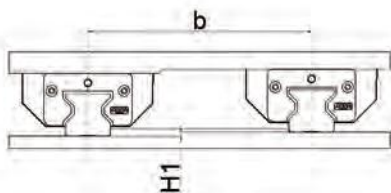

To obtain the maximum allowable deviation value in height, subtract the tolerance value of the dimension H (see the table about the accuracy classes on page 10) from the value $\Delta H1$ obtained by means of the following formula:

$$\Delta H1 = X \cdot b$$

Calculation factor	Preload class	
	P2	P3
X	$1,7 \cdot 10^{-4}$	$1,2 \cdot 10^{-4}$

Maximum allowable deviation in longitudinal direction

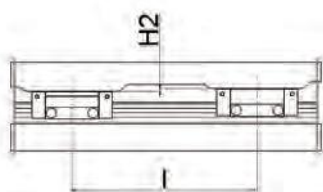

To obtain the maximum allowable deviation value in longitudinal direction, subtract the tolerance value of the dimension H (see the table about the accuracy classes on page 10) from the value $\Delta H2$ obtained by means of the following formula:

$$\Delta H2 = Y \cdot l$$

Calculation factor	Carriage type	
	LC/SC	LL/SL
Y	$4,5 \cdot 10^{-5}$	$3,5 \cdot 10^{-5}$

Parallelism tolerance for shoulder surfaces

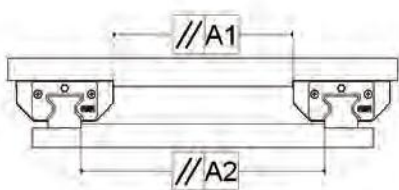

The specified tolerances are valid also for the guides and the carriages that are assembled without shoulders. The parallelism errors A1 and A2 cause an increase in the preload, but if the values specified in the table are not exceeded, their influence on the expected life will usually be negligible.

Parallelism ΔA per preload class (mm)		
Size	P2	P3
25	0,008	0,005
35	0,012	0,008
45	0,014	0,009
55	0,017	0,011
65	0,018	0,011

6.3 Assembly types

Assembly examples

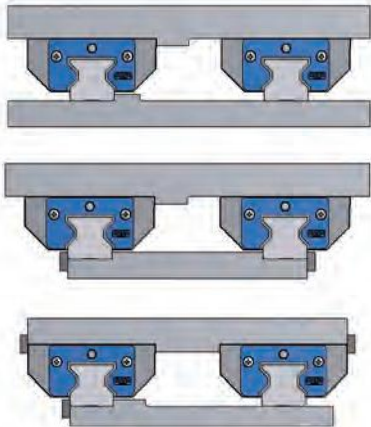

Some typical types of assembly are shown on the side. They differ as per the type of fastening for the carriage and the guide, as well as per the position of end stop surfaces in the machine.

Monoguide

Both side supports of the guide can be used as a reference side.

Carriages

The ground side surface is used as a reference side.

General instructions for the assembly of the guides

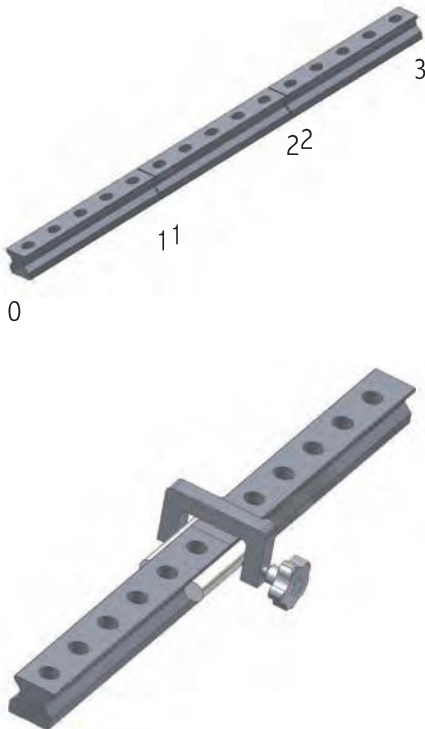

Comply with the following instructions:

- Always put the monoguide against the supporting end stop (if available)
- Always tighten the screws in an alternating way by starting from the centre of the guide and preferably by using a dynamometric wrench
- The guides formed by several parts are marked with numbers in the joints. During the assembly, you must match the aforesaid numbers. Always check that the guides are aligned one close to the other without leaving empty spaces, even tiny ones.

As for the assembly of thee guides in several parts (no side end stop), align the joints of the guides by using ground shafts and clamp, as shown in the picture.