

EGIS



**PRECISION FLAT CAGE
GUIDANCE SYSTEMS**



Linear guidance systems with rolling elements

have established a position for themselves in the machine building industry as have roller bearings for rotary motion. They are essential wherever the requirement is smooth running combined with minimal construction and maintenance expenditure. Characteristics such as load carrying capacity, rigidity and precision also have an important role to play. Moreover, a wide range of tailor-made solutions are required which have to be adapted to each individual construction requirement.

If a high level of precision, load carrying capacity and rigidity are required, as is generally the case with machine tools, precision linear guidance systems with needle or cylindrical roller flat cage assemblies without recirculating rolling elements offer an optimum solution. Compared with other linear systems, they require a smaller construction space, are used as locating or non-locating bearings depending on the configuration and are suitable for high accelerations. Due to the relative movement of the cage along the two raceways, they are particularly suitable for limited strokes. In contrast to linear guidance systems with recirculating rolling elements, the rolling elements are positioned between the raceways throughout the entire motion sequence. This guarantees exceptionally quiet running and a high level of running accuracy.

If specific space requirements are taken into account, the needle roller offers the longest bearing length together with the largest possible number of supporting rolling elements. The large number of linear contact points guarantees a significant load carrying capacity and rigidity. If the need for rigidity is not particularly important, the cylindrical roller provides a guidance system with greater elasticity. In this case, the high load carrying capacity which is characteristic of all these guidance systems is maintained.

Just as machine manufacturers automatically entrust specialised companies with the production of ball, roller or needle roller bearings, it is also advisable that they contact qualified specialists to produce linear guidance systems with rolling elements. EGIS, a medium-sized Swiss company, has been specialising for 50 years in the production of high-precision linear guidance systems which are essentially used in the following fields:

- Machine tool construction**
- Printing machines**
- Measurement technology**
- Automation**
- Robotics**
- Optics**
- Productronics**
- Medical technology**

In addition to a detailed technical section, this catalogue contains comprehensive information on the far-reaching EGIS programme for precision guideways in standard and made-to-measure lengths and the associated flat and angled flat cage assemblies as well as instructions relating to manufacturing possibilities for special parts to suit customers' requirements.

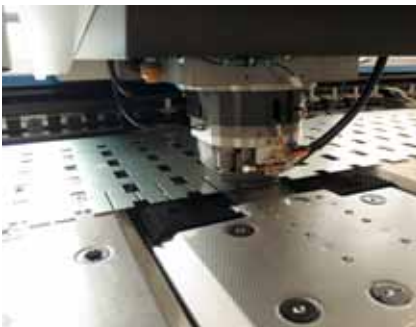

PRODUCT OVERVIEW

M AND V GUIDEWAYS

WITH NEEDLE OR CYLINDRICAL
ROLLER FLAT CAGE ASSEMBLY

M and V guideways are combined with angled flat cage assemblies and are particularly suitable for high load carrying capacities, rigidity, minimal friction and a high level of accuracy. They are used as linear locating bearings. They are manufactured in standard lengths up to a maximum of 1,000 mm which allows for rapid delivery.

In order to respond to specific customer requirements, the guideways in this range can also be supplied in made-to-measure lengths, i.e. in any required length up to the maximum length specified in the dimension table.

The guidance systems can be set to be free of clearance or can be preloaded to enhance rigidity using pressure screws.

ML GUIDEWAYS

WITH ADJUSTING GIB
FOR NEEDLE ROLLER FLAT CAGE ASSEMBLIES

This series combines an M guideway with an adjusting gib which distributes the preload equally over the entire length of the guidance system.

The pitch of the gib surface is 1.5%. ML guideways fulfil optimum requirements in terms of rigidity and precision.



MVZ (M/V/ML) GUIDEWAYS WITH INTEGRATED TOOTHED RACK FOR POSITIVE CONTROL OF THE NEEDLE ROLLER FLAT CAGE ASSEMBLY

In this series, the angled flat cage assembly is subjected to positive control by an integrated toothed wheel / toothed rack unit. This guarantees perfect movement for the flat cage assembly even under difficult operating conditions.



M AND ML GUIDEWAYS WITH SLIDING LAYER

The guideways in this series consist of an unhardened guideway with a layer fixed by adhesive. They are combined with V guideways and possess the same mounting dimensions as the M/ML and V guideways with flat cage assemblies. They are used in particular when an increased level of friction is required to provide damping or when static or pulsating loads are involved.



S AND J GUIDEWAYS

WITH NEEDLE ROLLER FLAT CAGE ASSEMBLY

These guideways are used in combination with needle roller flat cage assemblies as linear non-locating bearings. They are supplied in two versions, one of which possesses a flat structure and is therefore space-saving whilst the other has the same dimensions as the corresponding M and V guideways.



LUE COUNTERSTAY SYSTEM

WITH NEEDLE ROLLER AND CYLINDRICAL ROLLER FLAT CAGE ASSEMBLIES

These units consist of a locating guidance system, a non-locating guidance system and an L counterstay which preloads the two guidance systems. This arrangement prevents the system from becoming distorted by thermal expansion.

The LUE counterstay system provides the highest level of precision of all linear guidance systems with rolling elements.



FLAT CAGE ASSEMBLIES

Flat cage assemblies consist of a basic cage made from plastic or metal and a large number of precisely guided rolling elements. Needle rollers provide a minimal construction height and optimum load carrying capacity and rigidity whilst cylindrical rollers are less demanding with regard to the connecting structure and have a slightly less rigidity. Balls create the lowest level of friction of all rolling bearings.

Flat cage assemblies are designed for use with precision guideways but can also be used directly with customer-specific elements with appropriate raceways.



ACCESSORIES

END PIECES, WIPERS, INSERT NUTS

End pieces prevent the cage assembly from moving out of the loaded zone. Wipers protect the raceways against soiling under normal operating conditions.

Insert nuts allow for the transforming of a counterbore into a threaded hole.



SPECIAL DESIGNS

Guideways for cross roller and ball flat cage assemblies
 Guideways for hydrostatic guidance systems
 Guideways for air bearings
 Guideways with specific shapes and dimensions
 Linear recirculating roller bearings (RUSW and U-100)



2

M AND V GUIDEWAYS WITH NEEDLE OR CYLINDRICAL ROLLER FLAT CAGE ASSEMBLY

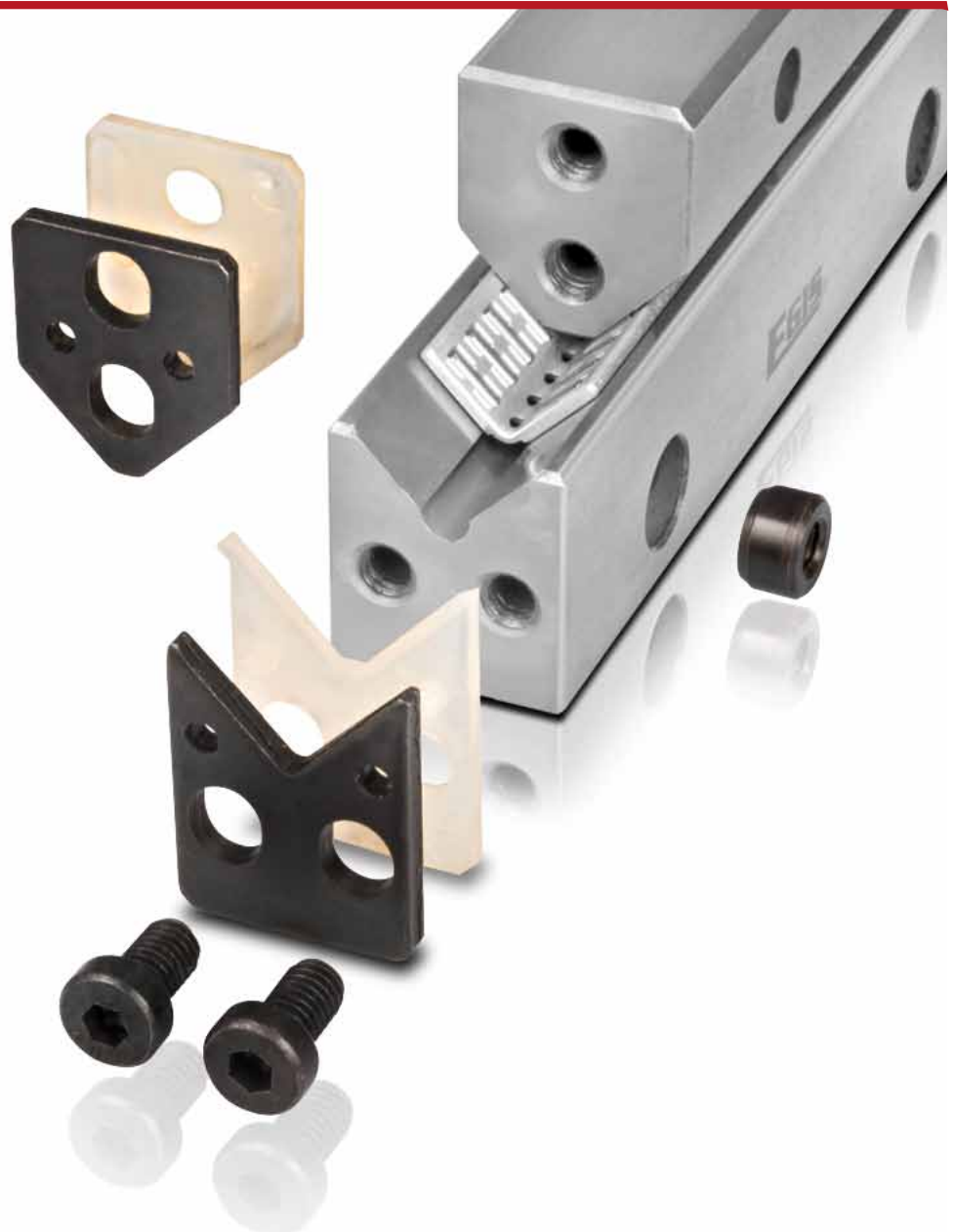

A MATERIAL

Hardened tool steel 1.2842 HRc 58 – 62.

B QUALITY

Raceways and locating faces are precision ground.

The guideways are available in 3 qualities (parallelism tolerance of the raceways on the reference sides of the guideway in relation to a defined length).

- Q10: normal quality for general machine construction
- Q6: precise quality for machine tool construction
- Q2: particularly precise quality for exceptionally demanding structures

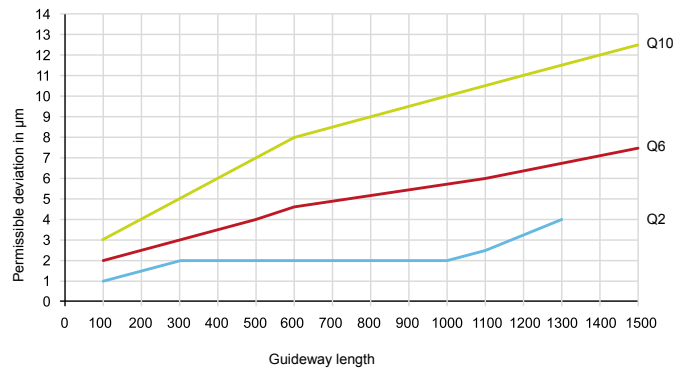

SPECIAL EXECUTIONS
SEE CHAPTER 10 ALTERNATIVE VERSIONS

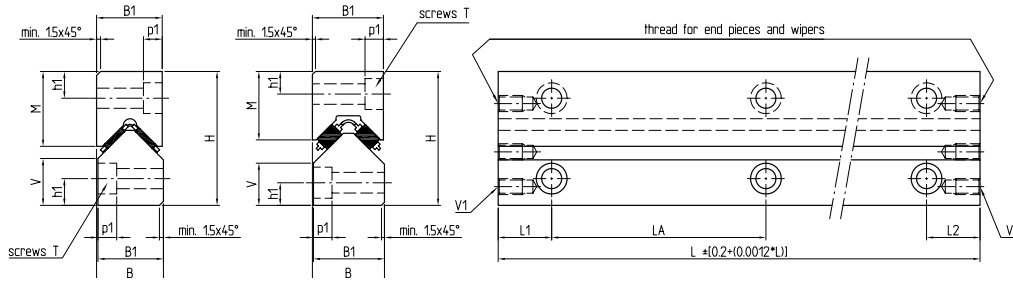

DIMENSIONS IN MM

Type	Dimensions					Fixing holes							Threads
	H 0/-0.2	B 0/-0.1	B1 0/-0.2	M	V	Screws T ****	h1	p1	t min.	LA***	L1** min.	L2** min.	V1
M3015	30	15	15	15.75	-	M4	5.5	4.6	15	40°	15	15	M3
V3015	30	15	15	-	10.5	M4	5.5	4.6	15	40°	15	15	M3
M3115	31	15	15	16	-	M4	6	5.2	15	50°	25	25	M3
V3115	31	15	15	-	11	M4	6	5.2	15	50°	25	25	M3
M4020	40	20	20	22.5	-	M6	7.5	6.9	20	80°	15	15	M5
V4020	40	20	20	-	13.5	M6	7.5	6.9	20	80°	15	15	M5
M4422	44	22	22	23.1	-	M6	9	6.9	22	80°	15	15	M5
V4422	44	22	22	-	16.6	M6	9	6.9	22	80°	15	15	M5
M4525	45	25	25	22.75	-	M6	7.5	6.9	15	80°	20	20	M6
V4525	45	25	25	-	14	M6	7.5	6.9	15	80°	20	20	M6
M5025	50	25	25	28	-	M6	10	6.9	15	80°	20	20	M6
V5025	50	25	25	-	17	M6	10	6.9	15	80°	20	20	M6
M6035	60	35	35	35	-	M8	11	9.1	20	100	20	20	M6
V6035	60	35	35	-	20	M8	11	9.1	20	100	20	20	M6
M6535	65	35	35	33.25	-	M8	11	9.1	20	100	20	20	M6
V6535	65	35	35	-	20	M8	11	9.1	20	100	20	20	M6
M7040	70	40	40	40	-	M10	13	11.1	25	100	20	20	M6
V7040	70	40	40	-	24	M10	13	11.1	25	100	20	20	M6
M8050	80	50	50	45	-	M12	14	13.1	30	100	20	20	M6
V8050	80	50	50	-	26	M12	14	13.1	30	100	20	20	M6
M8550	85	50	50	42.25	-	M12	14	13.1	30	100	20	20	M6
V8550	85	50	50	-	26	M12	14	13.1	30	100	20	20	M6

* M/V3015: length (L) 100mm, hole distances (LA) = 35mm
 M/V4422: length (L) 100mm, hole distances (LA) = 50mm
 M/V5025: length (L) 100mm, hole distances (LA) = 50mm

* M/V4020: length (L) 100mm, hole distances (LA) = 50mm
 M/V4525: length (L) 100mm, hole distances (LA) = 50mm

** L1 and L2 are the same size at both ends of the guideways and dependent on the guideway length without any specific requests being made

*** The tolerance of the hole distances (LA) is in proportion to the length tolerance

**** 4 hole types in the guideways for screw size T (according to the drawing below)

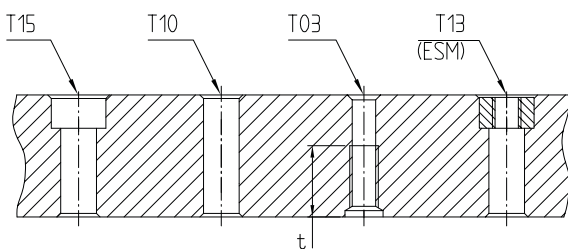

T15: Sinkhole for screws ISO 4762
 T10: Clearance hole
 T03: Threaded hole, thread length "t"
 T13: Sinkhole as T15, but with insert nuts ESM

STANDARD LENGTHS (MM)

Dimensions		100	150	200	300	400	500	600	700	800	900	1000	Made-to-measure lengths up to L max
M3015	V3015	●	●	●	●	●	●	○					600
M3115	V3115	○	○	○	○	○	○	○					600
M4020	V4020	●	●	●	●	●	●	●	●	●	○	○	1000
M4422	V4422	○		○	○	○	○	○	○	○	○	○	1000
M4525	V4525	○		○	○	○	○	○	○	○	○	○	1000
M5025	V5025	●		●	●	●	●	●	●	●	○	○	1300
M6035	V6035			○	○	○	○	○	○	○	○	○	1300
M6535	V6535			○	○	○	○	○	○	○	○	○	1300
M7040	V7040			○	○	○	○	○	○	○	○	○	1300
M8050	V8050				○	○	○	○	○	○	○	○	1300
M8550	V8550				○	○	○	○	○	○	○	○	1300

● = ex stock, hardened, pre-ground
 ○ = ex stock, non-hardened, non-ground
 Special lengths available on request

CAGE ALLOCATION

Guideways	Rolling elements	Plastic	Aluminium	Steel	Brass	Brass (with damping)
M/V3015	Needle rollers			E-HW10 F	E-HW10 MS	
M/V3115	Needle rollers			E-HW10 F	E-HW10 MS	
M/V4020	Needle rollers	E-FFW2025	E-HW15	E-HW15 F	E-HW15 MS	E-HGW15
M/V4422	Needle rollers	E-FFW2025	E-HW15	E-HW15 F	E-HW15 MS	E-HGW15
M/V4525	Cylindrical rollers		E-HRW50			
M/V5025	Needle rollers	E-FFW2025	E-HW15 E-HW16	E-HW15 F	E-HW15 MS E-HW16 MS	E-HGW15
M/V6035	Needle rollers	E-FFW2535	E-HW20	E-HW20 F	E-HW20 MS	E-HGW20
M/V6535	Cylindrical rollers		E-HRW70			
M/V7040	Needle rollers	E-FFW3045	E-HW25	E-HW25 F	E-HW25 MS	E-HGW25
M/V8050	Needle rollers	E-FFW3555	E-HW30	E-HW30 F	E-HW30 MS	E-HGW30
M/V8550	Cylindrical rollers		E-HRW100			

3

ML GUIDEWAYS WITH ADJUSTING GIB AND **V GUIDEWAYS** WITH NEEDLE ROLLER FLAT CAGE ASSEMBLY



A MATERIAL

Hardened tool steel 1.2842 HRc 58 – 62
(non-hardened adjusting gib).

B QUALITY

Raceways and locating faces are precision ground.

The guideways are available in 2 qualities for the ML guideways and 3 qualities for the V guideways (parallelism tolerance of the raceways on the reference sides of the guideways in relation to a defined length).

- Q10: normal quality for general machine construction (ML and V)
- Q6: precise quality for machine tool construction (ML and V)
- Q2: particularly precise quality for exceptionally demanding structures (V)

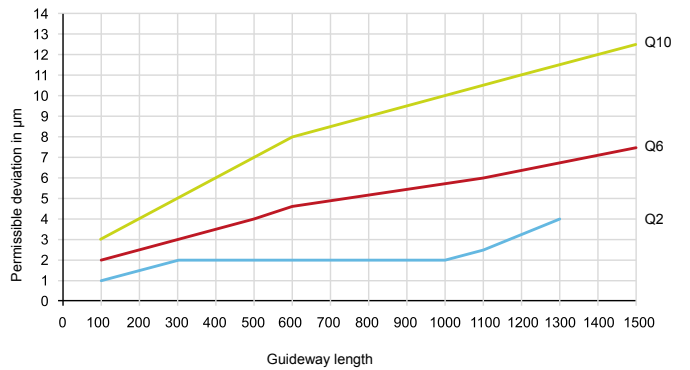

SPECIAL EXECUTIONS
SEE CHAPTER 10 ALTERNATIVE VERSIONS

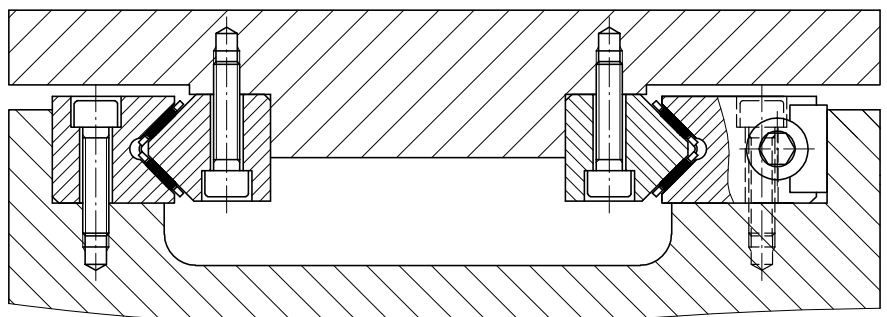

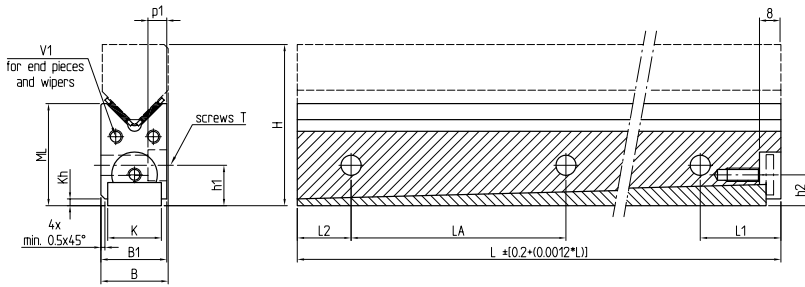

Type	Dimensions						Fixing holes							Gib screws	Threads
	H*	B 0/-0.1	B1 0/-0.2	ML*	K	Kh*	Screws T ****	h1*	p1 min.	t	LA	L1*** min.	L2*** min.	h2	V1
ML5020	50	20	20	32.5	15	5.5	M6	17.5	6.8	20	80**	30	15	15	M4
ML5520	55	20	20	37.5	15	6	M6	22.5	6.8	20	80	30	15	20	M4
ML5525	55	25	25	32.5	20	2.5	M6	15	6.8	15	80**	30	20	11.5	M5
ML6025	60	25	25	37.5	20	3.5	M6	20	6.8	15	80	30	20	16.5	M5
ML6525	65	25	25	42.5	20	5	M6	25	6.8	15	80	30	20	21.5	M5
ML7025	70	25	25	47.5	20	6.5	M6	30	6.8	15	80	30	20	26.5	M5
ML7035	70	35	35	45	25	3	M8	21	9	20	100**	32	20	15.5	M6
ML8035	80	35	35	55	25	5	M8	31	9	20	100	32	20	25.5	M6
ML8040	80	40	40	50	30	3	M10	23	11	25	100**	32	20	16	M6
ML9040	90	40	40	60	30	5	M10	33	11	25	100	32	20	26	M6
ML9050	90	50	50	55	40	3	M12	24	13	30	100**	32	20	15.5	M6
ML10050	100	50	50	65	40	5	M12	34	13	30	100	32	20	25.5	M6

* These dimensions are dependent on the gib position, adjustment range ± 0.5

** ML5020 + ML5525 + ML7035 + ML8040 + ML9050: length (L) 100mm, hole distance (LA) = 50mm

The tolerance of the hole distances (LA) is in proportion to the length tolerance

*** L1 and L2 are the same size at both ends of the guideways and dependent on the guideway length without any specific requests being made

**** 3 hole types in the guideways for screw size T (according to the drawing below)

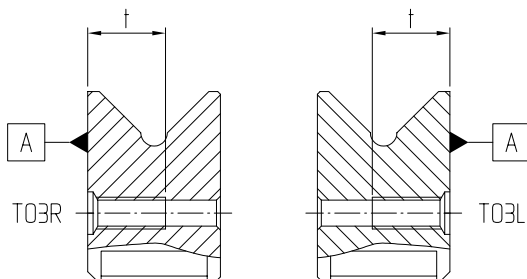

T15: Sinkhole for screws ISO 4762
Depending on left or right guideway

T03: Threaded hole, thread length "t"
Depending on left or right guideway

T13: Sinkhole as T15, but with insert nuts ESM
Depending on left or right guideway

[A]: Reference side

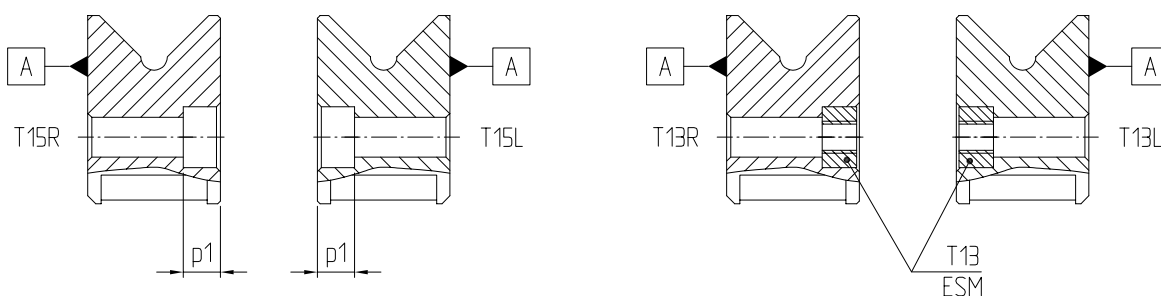

STANDARD LENGTHS (MM)

Dimensions	100	200	250	300	400	500	600	700	750	800	900	1000
ML5020	o	o		o								
ML5520					o	o	o					
ML5525	o	o	o									
ML6025				o	o	o						
ML6525							o	o	o			
ML7025										o	o	o
ML7035	o	o		o	o	o						
ML8035							o	o		o	o	o
ML8040	o	o		o	o	o						
ML9040							o	o		o	o	o
ML9050	o	o		o	o	o						
ML10050							o	o		o	o	o

o = ex stock, non-hardened, non-ground
 Special lengths available on request

CAGE ALLOCATION

Guideways	Rolling elements	Plastic	Aluminium	Steel	Brass	Brass (with damping)
ML5020	Needle rollers	E-FFW2025	E-HW15	E-HW15 F	E-HW15 MS	E-HGW15
ML5520	Needle rollers	E-FFW2025	E-HW15	E-HW15 F	E-HW15 MS	E-HGW15
ML5525	Needle rollers	E-FFW2025	E-HW15 E-HW16	E-HW15 F	E-HW15 MS E-HW16 MS	E-HGW15
ML6025	Needle rollers	E-FFW2025	E-HW15 E-HW16	E-HW15 F	E-HW15 MS E-HW16 MS	E-HGW15
ML6525	Needle rollers	E-FFW2025	E-HW15 E-HW16	E-HW15 F	E-HW15 MS E-HW16 MS	E-HGW15
ML7025	Needle rollers	E-FFW2025	E-HW15 E-HW16	E-HW15 F	E-HW15 MS E-HW16 MS	E-HGW15
ML7035	Needle rollers	E-FFW2535	E-HW20	E-HW20 F	E-HW20 MS	E-HGW20
ML8035	Needle rollers	E-FFW2535	E-HW20	E-HW20 F	E-HW20 MS	E-HGW20
ML8040	Needle rollers	E-FFW3045	E-HW25	E-HW25 F	E-HW25 MS	E-HGW25
ML9040	Needle rollers	E-FFW3045	E-HW25	E-HW25 F	E-HW25 MS	E-HGW25
ML9050	Needle rollers	E-FFW3555	E-HW30	E-HW30 F	E-HW30 MS	E-HGW30
ML10050	Needle rollers	E-FFW3555	E-HW30	E-HW30 F	E-HW30 MS	E-HGW30

4

GUIDEWAYS WITH INTEGRATED TOOTHED RACK MVZ (M/V/ML) FOR POSITIVE CONTROL OF THE NEEDLE ROLLER FLAT CAGE ASSEMBLY



A MATERIAL

Hardened tool steel 1.2842 HRc 58 – 62.

B QUALITY

Raceways and locating faces are precision ground.

The guideways are available in 3 qualities (parallelism tolerance of the raceways on the reference sides of the guideway in relation to a defined length).

- Q10: normal quality for general machine construction
- Q6: precise quality for machine tool construction
- Q2: particularly precise quality for exceptionally demanding structures

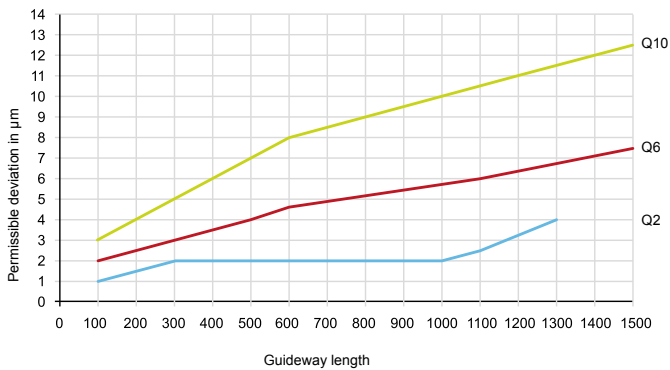

SPECIAL EXECUTIONS
SEE CHAPTER 10 ALTERNATIVE VERSIONS

C MATCHING BY SETS

MVZ – guideways with integrated toothed rack are supplied in sets and consist of:

- M and/or ML guideways with integrated toothed rack.
- V guideways with integrated toothed rack.
- Flat cage assemblies: E-HW F or E-HW with integrated toothed wheel for positive control of the cage assemblies.
- The assembly dimensions have the same mounting dimensions as the M/ML and V guideways with flat cage assemblies.

IMPORTANT ASSEMBLY INFORMATION

- Set numbering must be respected.
- When the guideways are being positioned, it is important to take into account the “X-X” labelling which guarantees the correct positioning of the guideways and cage assemblies in the central stroke position.

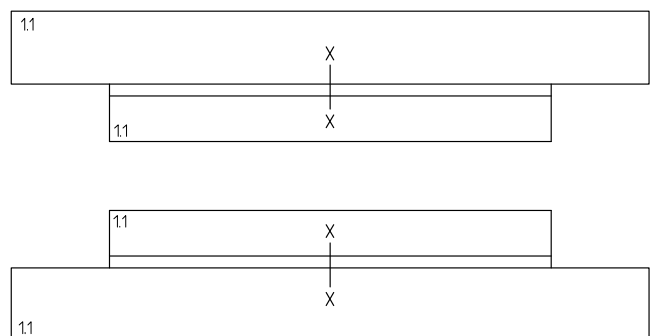

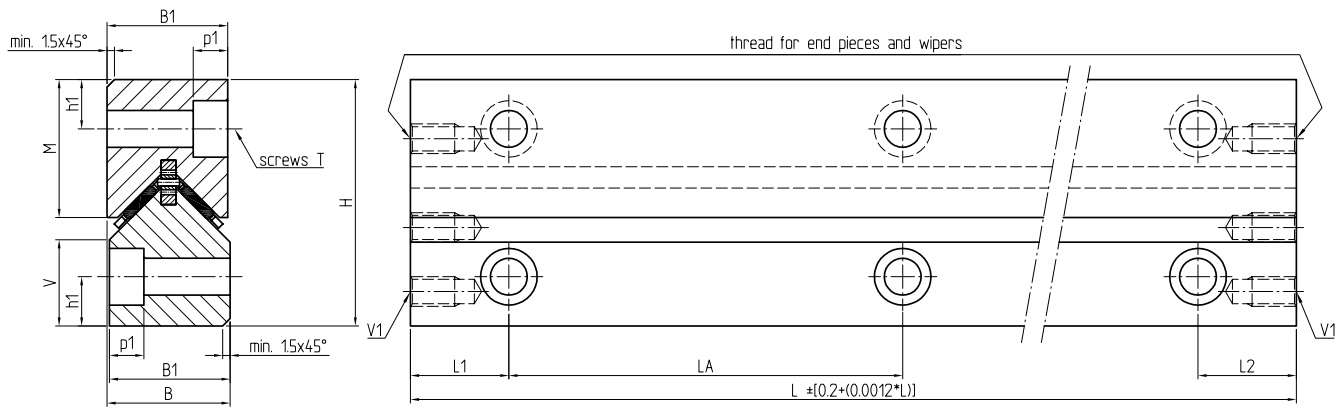

DIMENSIONS IN MM

Type	Dimensions					Fixing holes							Threads
	H 0/-0.2	B 0/-0.1	B1 0/-0.2	M	V	Screws T ****	h1	p1	t min.	LA***	L1** min.	L2** min.	V1
M3015	30	15	15	15.75	-	M4	5.5	4.6	15	40°	15	15	M3
V3015	30	15	15	-	10.5	M4	5.5	4.6	15	40°	15	15	M3
M4020	40	20	20	22.5	-	M6	7.5	6.9	20	80°	15	15	M5
V4020	40	20	20	-	13.5	M6	7.5	6.9	20	80°	15	15	M5
M5025	50	25	25	28	-	M6	10	6.9	15	80°	20	20	M6
V5025	50	25	25	-	17	M6	10	6.9	15	80°	20	20	M6
M6035	60	35	35	35	-	M8	11	9.1	20	100	20	20	M6
V6035	60	35	35	-	20	M8	11	9.1	20	100	20	20	M6
M7040	70	40	40	40	-	M10	13	11.1	25	100	20	20	M6
V7040	70	40	40	-	24	M10	13	11.1	25	100	20	20	M6
M8050	80	50	50	45	-	M12	14	13.1	30	100	20	20	M6
V8050	80	50	50	-	26	M12	14	13.1	30	100	20	20	M6

* M/V3015: length (L) 100mm, hole distances (LA) = 35mm
M/V4020: length (L) 100mm, hole distances (LA) = 50mm
M/V5025: length (L) 100mm, hole distances (LA) = 50mm
** L1 and L2 are the same size at both ends of the guideways and dependent on the guideway length without any specific requests being made
*** The tolerance of the hole distances (LA) is in proportion to the length tolerance
**** 4 hole types in the guideways for screw size T (according to the drawing below)

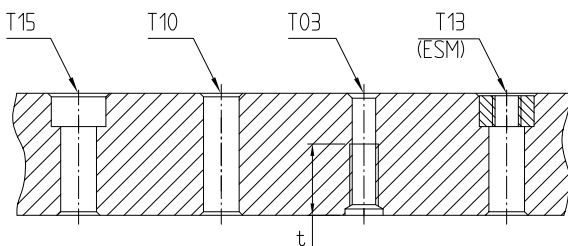

T15: Sinkhole for screws ISO 4762
T10: Clearance hole
T03: Threaded hole, thread length "t"
T13: Sinkhole as T15, but with insert nuts ESM

STANDARD LENGTHS (MM)

Dimensions		100	150	200	300	400	500	600	700	800	900	1000	Made-to-measure lengths up to L max.
M3015	V3015	o	o	o	o	o	o	o					600
M4020	V4020	o	o	o	o	o	o	o	o	o	o	o	1000
M5025	V5025	o		o	o	o	o	o	o	o	o	o	1300
M6035	V6035			o	o	o	o	o	o	o	o	o	1300
M7040	V7040			o	o	o	o	o	o	o	o	o	1300
M8050	V8050				o	o	o	o	o	o	o	o	1300

o = ex stock, non-hardened, non-ground
 Special lengths available on request

5

M AND ML GUIDEWAYS WITH SLIDING LAYER (TURCITE OR PERMAGLIDE)



A MATERIAL

M and ML guideways: non-hardened tool steel 1.2842 with affixed Turcite (LB) or Permagliding (LP21)- sliding layer.

C CHOICE OF COATING

Reference values	Layer	
	Turcite LB	Permagliding LP21
Specific permissible load capacity Static p_{max} [N/mm ²]	6	250
$p * v_{max}$ [N/mm ² * m/s]	1	3
Permissible temperature [°C]	-40° bis +80°	-40° bis +110°
Friction coefficient (without lubricant)	0.15 – 0.26	Not usable
Friction coefficient (with lubricant)	0.04 – 0.08	0.02 – 0.2

IMPORTANT INFORMATION

The use of M and ML guideway sets with a sliding layer and V guideways (without clearance or preloaded) in a rigid environment can result in uncontrolled friction in the presence of thermal expansion.

B QUALITY

The guideways with a sliding layer are available in 2 qualities (parallelism tolerance of the raceways on the reference sides of the guideways in relation to a defined length).

Q10: normal quality for general machine construction
 Q6: precise quality for machine tool construction

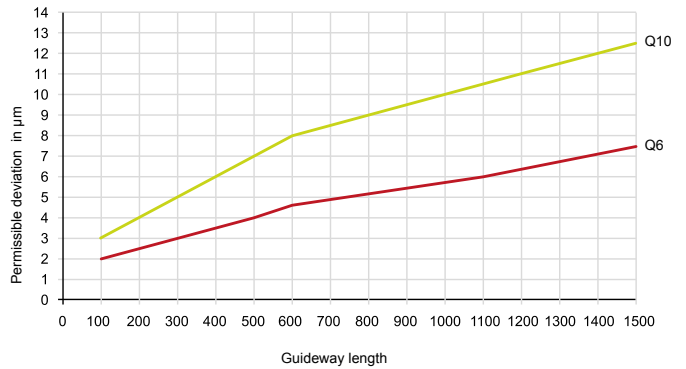

SPECIAL EXECUTIONS
 SEE CHAPTER 10 ALTERNATIVE VERSIONS

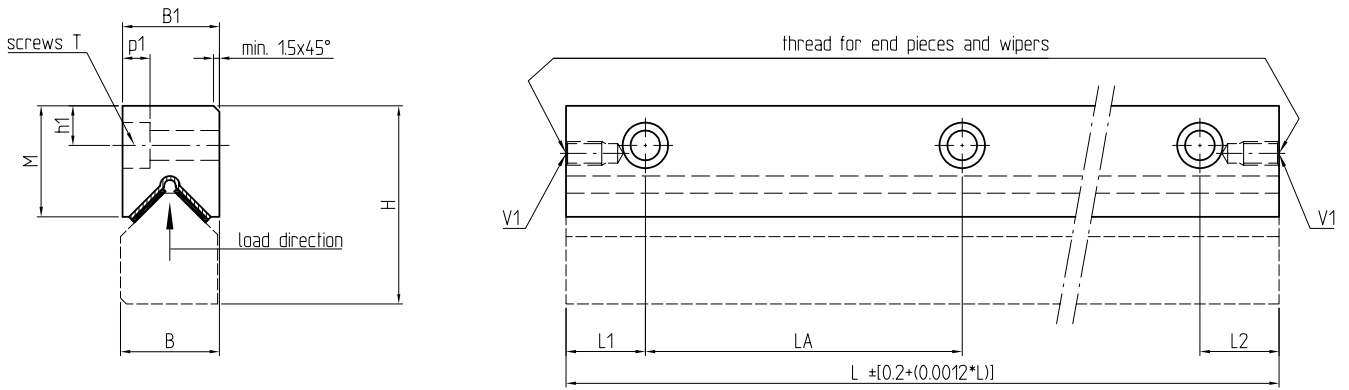

DIMENSIONS IN MM

Type	Dimensions					Fixing holes							Threads
	H 0/-0.2	B 0/-0.1	B1 0/-0.2	M	V	Screws T ****	h1	p1	t min.	LA***	L1** min.	L2** min.	V1
M3015	30	15	15	17.3	-	M4	5.5	4.6	15	40*	15	15	M3
M4020	40	20	20	23.6	-	M6	7.5	6.8	20	80*	15	15	M5
M5025	50	25	25	29.8	-	M6	10	6.8	15	80*	20	20	M6
M6035	60	35	35	36.3	-	M8	11	9.0	20	100	20	20	M6
M7040	70	40	40	41.3	-	M10	13	11.0	25	100	20	20	M6
M8050	80	50	50	46.3	-	M12	14	13.0	30	100	20	20	M6

* M3015: length (L) 100mm, hole distances (LA) = 35mm
 M4020: length (L) 100mm, hole distances (LA) = 50mm
 M5025: length (L) 100mm, hole distances (LA) = 50mm

** L1 and L2 are the same size at both ends of the guideways and dependent on the guideway length without any specific requests being made.

*** The tolerance of the hole distances (LA) is in proportion to the length tolerance

**** 4 hole types in the guideways for screw size T (according to the drawing below)

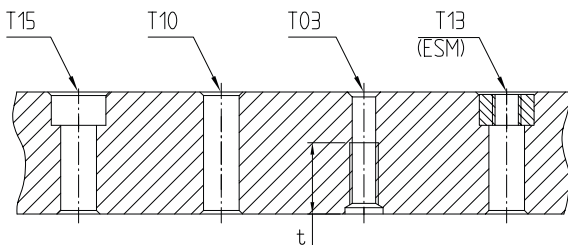

- T15: Sinkhole for screws ISO 4762
- T10: Clearance hole
- T03: Threaded hole, thread length "t"
- T13: Sinkhole as T15, but with insert nuts ESM

STANDARD LENGTHS (MM)

Dimensions	100	150	200	300	400	500	600	700	800	900	1000	Made-to-measure lengths up to L max.
M3015	o	o	o	o	o	o	o					600
M4020	o	o	o	o	o	o	o	o	o	o	o	1000
M5025	o		o	o	o	o	o	o	o	o	o	1300
M6035			o	o	o	o	o	o	o	o	o	1300
M7040			o	o	o	o	o	o	o	o	o	1300
M8050				o	o	o	o	o	o	o	o	1300

o = ex stock, non-hardened, non-ground
 Special lengths available on request

Dimensions	Maximum permissible static load*	
	Turcite LB (N)	Permaglide LP21 (N)
M3015	3'600	150'000
M4020	6'600	275'000
M5025	8'400	350'000
M6035	12'000	500'000
M7040	13'800	575'000
M8050	16'200	675'000

* For guideways with a length of 100 mm, load direction according to dimension diagram, see page 60

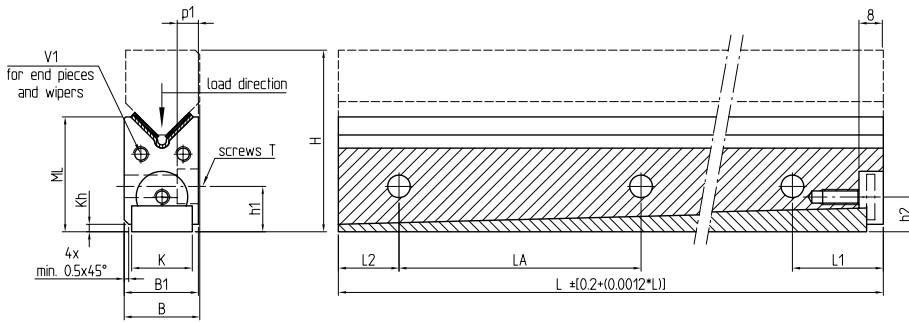

DIMENSIONS IN MM

Type	Dimensions						Fixing holes							Gib screws	Threads
	H*	B 0/-0.1	B1 0/-0.2	ML*	K	Kh*	Screws T ****	h1*	p1	t	LA	L1*** min.	L2*** Min.		
ML5020	50	20	20	33	15	5.5	M6	17.5	6.8	20	80**	30	15	15	M4
ML5520	55	20	20	38	15	6	M6	22.5	6.8	20	80	30	15	20	M4
ML5525	55	25	25	34	20	2.5	M6	15	6.8	15	80**	30	20	11.5	M5
ML6025	60	25	25	39	20	3.5	M6	20	6.8	15	80	30	20	16.5	M5
ML6525	65	25	25	44	20	5	M6	25	6.8	15	80	30	20	21.5	M5
ML7025	70	25	25	48	20	6.5	M6	30	6.8	15	80	30	20	26.5	M5
ML7035	70	35	35	45.5	25	3	M8	21	9	20	100**	32	20	15.5	M6
ML8035	80	35	35	55.5	25	5	M8	31	9	20	100	32	20	25.5	M6
ML8040	80	40	40	50.5	30	3	M10	23	11	25	100**	32	20	16	M6
ML9040	90	40	40	60.5	30	5	M10	33	11	25	100	32	20	26	M6
ML9050	90	50	50	56	40	3	M12	24	13	30	100**	32	20	15.5	M6
ML10050	100	50	50	66	40	5	M12	34	13	30	100	32	20	25.5	M6

* These dimensions are dependent on the gib position, adjustment range ± 0,5 mm

** ML5020 + ML5525 + ML7035 + ML8040 + ML9050: length (L) 100mm, hole distance (LA) = 50mm.

*** L1 and L2 are the same size at both ends of the guideways and dependent on the guideway length without any specific requests being made.

**** 3 hole types in the guideways for screw size T (according to the drawing below)

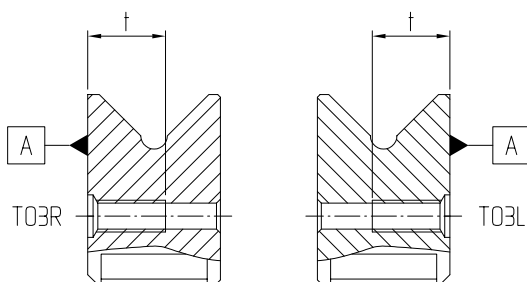

T15: Sinkhole for screws ISO 4762
Depending on left or right guideway

T03: Threaded hole, thread length "t"
Depending on left or right guideway

T13: Sinkhole as T15, but with insert nuts ESM
Depending on left or right guideway

[A]: Reference side

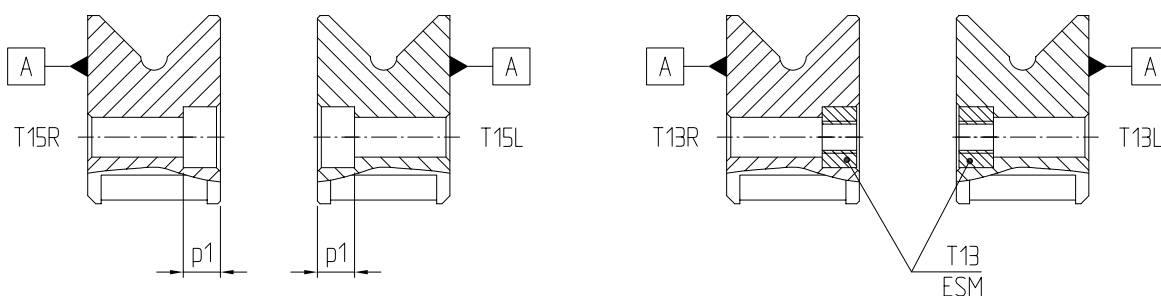

STANDARD LENGTHS (MM)

Dimensions	100	200	250	300	400	500	600	700	750	800	900	1000
ML5020	○	○		○								
ML5520					○	○	○					
ML5525	○	○	○									
ML6025				○	○	○						
ML6525							○	○	○			
ML7025										○	○	○
ML7035	○	○		○	○	○						
ML8035							○	○		○	○	○
ML8040	○	○		○	○	○						
ML9040							○	○		○	○	○
ML9050	○	○		○	○	○						
ML10050							○	○		○	○	○

○ = ex stock, non-hardened, non-ground
 Special lengths available on request

Dimensions	Maximum permissible static load*	
	Turcite LB (N)	Permaglide LP21 (N)
ML5020 ML5520	6'600	275'000
ML5525 ML6025 ML6525 ML7025	8'400	350'000
ML7035 ML8035	12'000	500'000
ML8040 ML9040	13'800	575'000
ML9050 ML10050	16'200	675'000

* For guideways with a length of 100mm, load direction according to dimension diagram, see page 62

6

S AND J GUIDEWAYS WITH NEEDLE ROLLER FLAT CAGE ASSEMBLY



A MATERIAL

Hardened tool steel 1.2842 HRc 58 – 62.

B QUALITY

The raceways and locating faces are precision ground.

The guideways are available in 3 qualities (parallelism tolerance of the raceways on the reference sides of the guideway in relation to a defined length).

- Q10: normal quality for general machine construction
- Q6: precise quality for machine tool construction
- Q2: particularly precise quality for exceptionally demanding structures

IMPORTANT INFORMATION

The correct functioning of the guideways is dependent above all on the precision of the locating faces.

MATCHING IN SETS

Matching in sets “M/V/S/J” (4SX) when an order is placed allows for installation without insert plate or ML guideway. The guideways are labelled by sets. The tolerance of the height difference must be maintained with the connecting parts in this case.

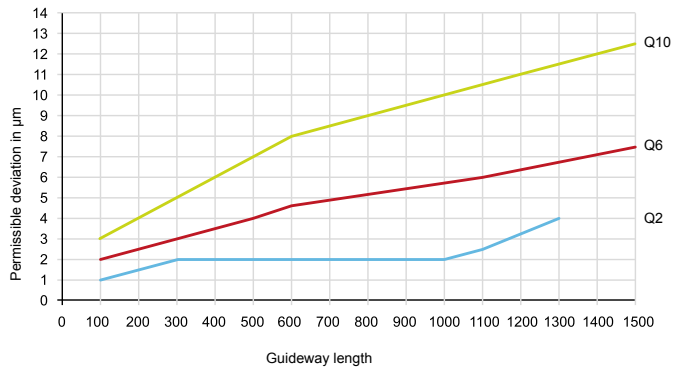

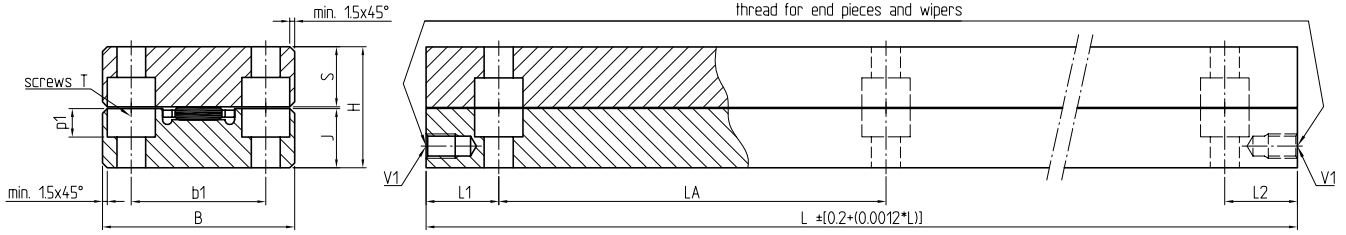

DIMENSIONS IN MM

Type	Dimensions				Fixing holes							Threads
	H	B	S	J	Screws T****		b1	p1	LA***	L1***	L2**	V1
	0/-0.2	0/-0.2			T15	T03				min.	min.	
S3525	25	35	13	-	M5	M6	22	(5.7)	80*	15	15	-
J3525	25	35	-	11.8	M5	M6	22	(5.7)	80*	15	15	M5
S4025	25	40	12.5	-	M5	M6	28	(5.7)	80*	15	15	-
J4025	25	40	-	12.3	M5	M6	28	(5.7)	80*	15	15	M5
S5030	30	50	15	-	M6	M6	35	(6.8)	100*	15	15	-
J5030	30	50	-	14.8	M6	M6	35	(6.8)	100*	15	15	M6
S5530	30	55	14.5	-	M6	M6	40	(6.8)	100*	15	15	-
J5530	30	55	-	15.3	M6	M6	40	(6.8)	100*	15	15	M6

* S/J3525: length (L) 100mm, hole distances (LA) = 50mm
 S/J4025: length (L) 100mm, hole distances (LA) = 50mm
 S/J5030: length (L) 100mm, hole distances (LA) = 50mm
 S/J5530: length (L) 100mm, hole distances (LA) = 50mm

** L1 and L2 are the same size at both ends of the guideway and dependent on the guideway length without any specific requests being made.

*** The tolerance of the hole distances (LA) is in proportion to the length tolerance

**** 2 hole types in the guideways for screw size T (according to the drawing below)

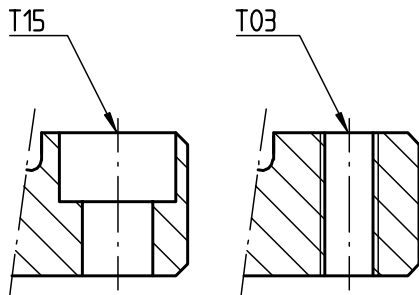

T15: Sinkhole for screws ISO 4762
 T03: Threaded hole

STANDARD LENGTHS (MM)

Dimensions		100	200	300	400	500	600	700	800	900	1000	Made-to-measure lengths up to L max.
S3525	J3525	○	○	○	○	○	○	○	○	○	○	1300
S4025	J4025	○	○	○	○	○	○	○	○	○	○	1300
S5030	J5030	○	○	○	○	○	○	○	○	○	○	1300
S5530	J5530	○	○	○	○	○	○	○	○	○	○	1300

○ = ex stock, non-hardened, non-ground
 Special lengths available on request

CAGE ALLOCATION

Guideways	Rolling elements	Plastic	Aluminium	Steel	Brass	Brass (with damping)
S/J3525	Needle rollers	E-FF2010	E-H10	E-H10 F	E-H10 MS	E-HG10
S/J4025	Needle rollers Cylindrical rollers	E-FF2515	E-H15 E-HB2515	E-H15 F	E-H15 MS	E-HG15
S/J5030	Needle rollers Cylindrical rollers	E-FF3020	E-H20 E-HB3020	E-H20 F E-BF3020	E-H20 MS	E-HG20
S/J5530	Needle rollers Cylindrical rollers	E-FF3525	E-H25 E-HB4025	E-H25 F	E-H25 MS	E-HG25

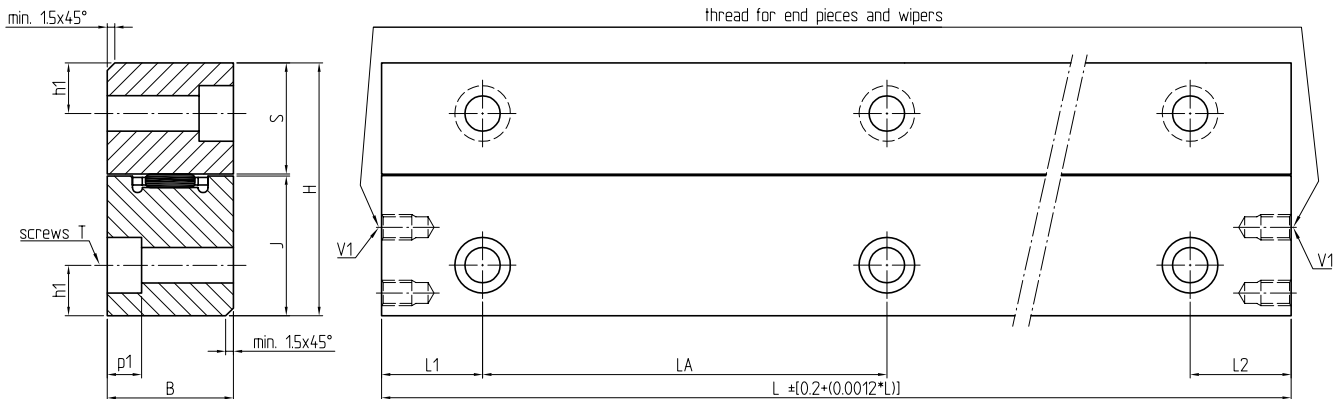

DIMENSIONS IN MM

Type	Dimensions				Fixing holes							Threads
	H 0/-0.2	B 0/-0.2	S	J	Screws T ****	h1	p1	t min.	LA***	L1** min.	L2** min.	V1
S5025	50	25	22	-	M6	10	(6.8)	15	80*	20	20	-
J5025	50	25	-	27.7	M6	10	(6.8)	15	80*	20	20	M6
S6035	60	35	25	-	M8	11	(9)	20	100*	20	20	-
J6035	60	35	-	34.7	M8	11	(9)	20	100*	20	20	M6
S7040	70	40	30	-	M10	13	(11)	25	100*	20	20	-
J7040	70	40	-	39.7	M10	13	(11)	25	100*	20	20	M6
S8050	80	50	35	-	M12	14	(13)	30	100*	20	20	-
J8050	80	50	-	44.7	M12	14	(13)	30	100*	20	20	M6

- * S/J5025: length (L) 100mm, hole distances (LA) = 50mm
- S/J6035: length (L) 100mm, hole distances (LA) = 50mm
- S/J7040: length (L) 100mm, hole distances (LA) = 50mm
- S/J8050: length (L) 100mm, hole distances (LA) = 50mm

** L1 and L2 are the same size at both ends of the guideway and dependent on the guideway length without any specific requests being made

*** The tolerance of the hole distances(LA) is in proportion to the length tolerance

**** 2 hole types in the guideways for screw size T (according to the drawing below)

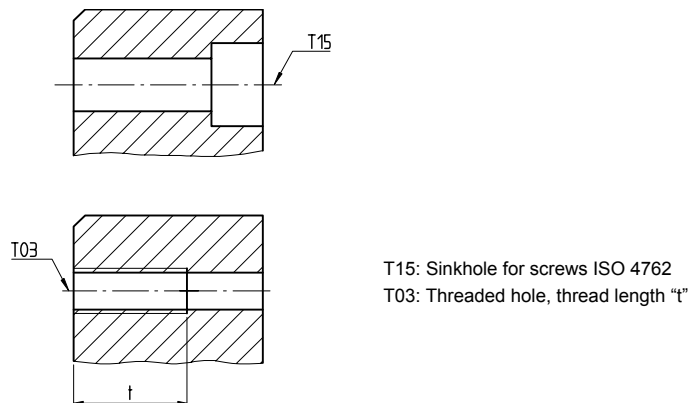

T15: Sinkhole for screws ISO 4762

T03: Threaded hole, thread length "t"

STANDARD LENGTHS (MM)

Dimensions		100	200	300	400	500	600	700	800	900	1000	Made-to-measure lengths up to L max.
S5025	J5025	○	○	○	○	○	○	○	○	○	○	1000
S6035	J6035	○	○	○	○	○	○	○	○	○	○	1000
S7040	J7040	○	○	○	○	○	○	○	○	○	○	1300
S8050	J8050	○	○	○	○	○	○	○	○	○	○	1300

○ = ex stock, non-hardened, non-ground
 Special lengths available on request

CAGE ALLOCATION

Guideways	Rolling elements	Plastic	Aluminium	Steel	Brass	Brass (with damping)
S/J5025	Needle rollers	E-FF2515	E-H15	E-H15 F	E-HG15	E-HG15
S/J6035	Needle rollers	—	E-H24 ZW	E-H24 ZW F	E-H24 ZW MS	—
S/J7040	Needle rollers	—	E-H34 ZW	E-H34 ZW F	E-H34 ZW MS	—
S/J8050	Needle rollers	—	E-H44 ZW	E-H44 ZW F	E-H44 ZW MS	—

7

LUE – COUNTERSTAY SYSTEM WITH NEEDLE AND CYLINDRICAL ROLLER FLAT CAGE ASSEMBLIES



The LUE counterstay system is particularly suited to high-precision applications. This system provides the highest level of accuracy of all linear guidance systems with rolling elements. It is the perfect solution when a high degree of accuracy and rigidity are required, particularly when the main load operates in a vertical or lateral direction. The separation between locating and non-locating bearings prevents the system from becoming distorted by thermal expansion.

The LUE counterstay system does not require any adjustment after assembly.

The system is preloaded by components which have been adjusted against one another in terms of dimensions. Preloading is established by observing the prescribed tightening torques during assembly without any adjustments being required.

A MATERIAL

M and V and S and J guideways: Hardened tool steel 1.2842 HRc 58 – 62

LU counterstays: counterstay bar (LUT) made from hardened tool steel 1.2842 HRc 58 – 62 and a distance bar (LUD) made from soft construction steel.

B QUALITY

The raceways and locating faces are precision ground.

Q2: particularly precise quality for exceptionally demanding structures

The LUE counterstay system is only supplied in Q2 quality, which is the highest quality for standard guideways (parallelism tolerance of the raceways to the reference sides of the guideways in relation to a defined length).

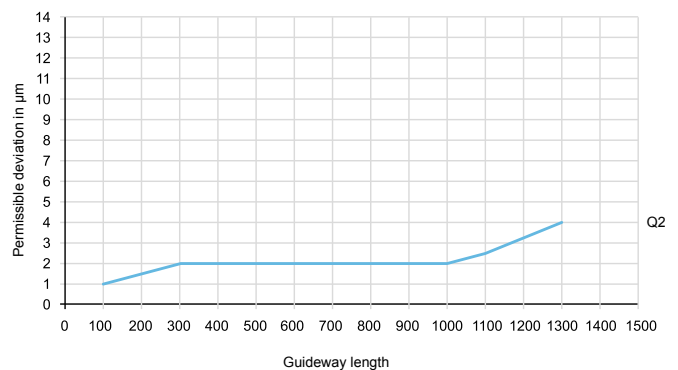

SPECIAL EXECUTIONS
SEE CHAPTER 10 ALTERNATIVE VERSIONS

C MATCHING IN SETS

The guideways are manufactured, labelled and packaged by sets.

NB

Under no circumstances must the counterstay components be mixed up as matching and preloading could no longer be guaranteed in that case.

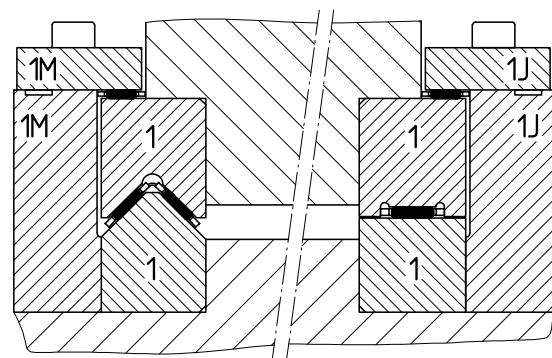

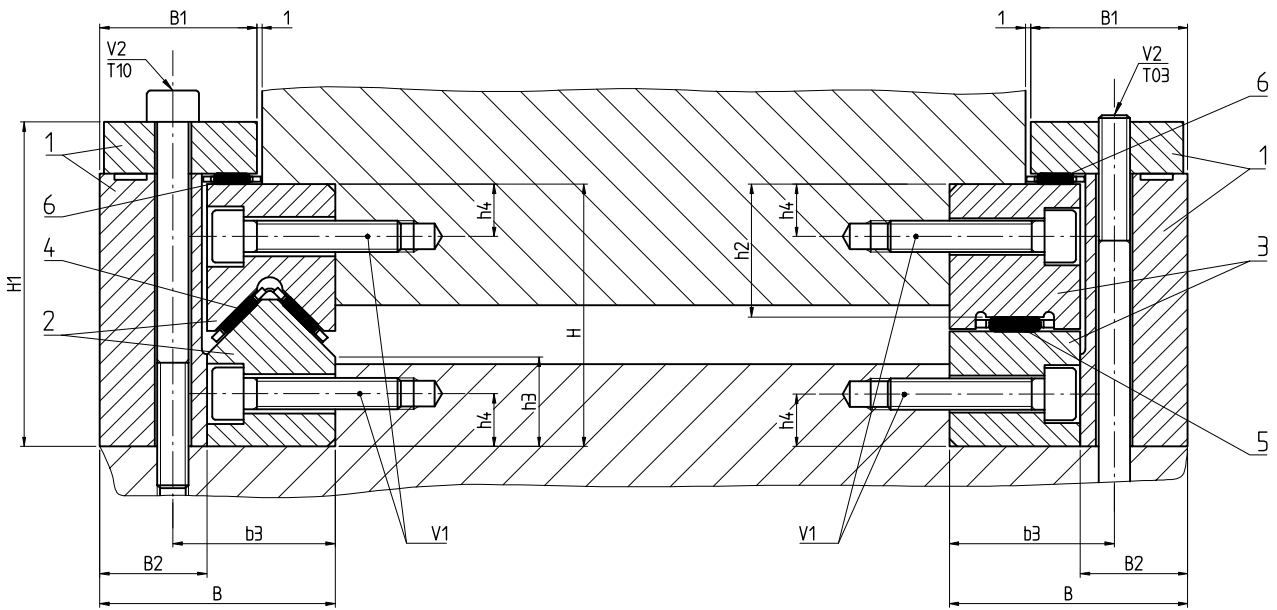

DIMENSIONS IN MM

Type	H 0/-0.2	H1	B	B1	B2	b3	V1	V2 T10 / T03	h2	h3	h4	L max.
LUE 5025	50	62	45	30	20	31	M6	M6	25.5	17	10	800
LUE 6035	60	77	60	40	25	42	M8	M8	33	20	11	1000
LUE 7040	70	89	65	40	25	47	M10	M8	37.5	24	13	1000
LUE 8050	80	100	86	51	36	61	M12	M12	42	26	14	1000

LUE COUNTERSTAY SYSTEM COMPONENTS:

Type	L1* min.	LA**	L2* min.	L max.
LU 5025	20	50	20	800
LU 6035	20	50	20	1000
LU 7040	20	50	20	1000
LU 8050	20	50	20	1000

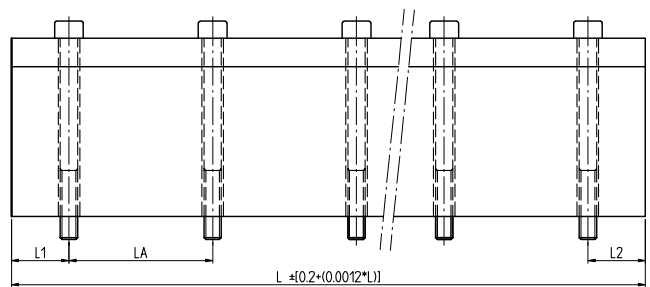

* L1 and L2 are the same size at both ends of the guideway and dependent on the guideway length without any specific requests being made.
 ** The tolerance of the hole distances (LA) is in proportion to the length tolerance

LUE COUNTERSTAY SYSTEM COMPONENTS:

Type	Counterstays	Guideways			Precision cages: G1	
	LU	M / V	J / S			
	Pos. 1	Pos. 2	Pos. 3	Pos. 4	Pos. 5	Pos. 6
LUE 5025	LU5025	5025	5025	E-HW15	E-H15	E-H10
LUE 6035	LU6035	6035	6035	E-HW20	E-H24 ZW	E-BF5015
LUE 7040	LU7040	7040	7040	E-HW25	E-H34 ZW	E-BF5015
LUE 8050	LU8050	8050	8050	E-HW30	E-H44 ZW	E-BF5015

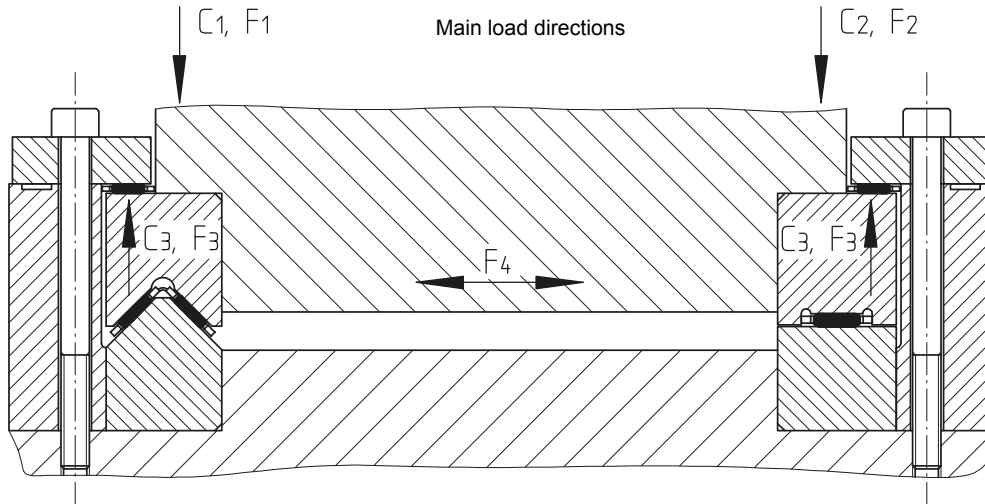

DIMENSIONS IN MM

Type	Load carrying capacity						
	Basic dynamic load ratings			Limiting loads*			
	C ₁ (N)	C ₂ (N)	C ₃ (N)	F ₁ (N)**	F ₂ (N)**	F ₃ (N)***	F ₄ (N)***
LUE 5025	25'960	35'620	21'410	13'840	15'630	1'200	7'500
LUE 6035	40'200	36'710	70'410	38'690	58'620	1'500	10'000
LUE 7040	62'840	56'850	70'410	42'500	61'720	2'500	16'000
LUE 8050	82'980	88'860	70'410	43'150	69'540	4'000	23'000

* For a theoretical cage length of 100 mm in load direction according to table (see above)
 Calculation of limiting loads for effective cage lengths:

$$F_{w1,2,3} = F_{1,2,3} \cdot \frac{L_k - 2e + t}{100} \text{ where } Z = \frac{L_k - 2e + 1}{100} = \text{whole number}$$

** limited by system preload

*** limited by load carrying capacity / friction locking effect of fixing screws

TIGHTENING TORQUE FOR FIXING SCREWS:

For V1 and V2 screws	Tightening torque
Strength category 10.9	Nm
M6	12
M8	29
M10	58
M12	101

8

FLAT CAGE ASSEMBLIES

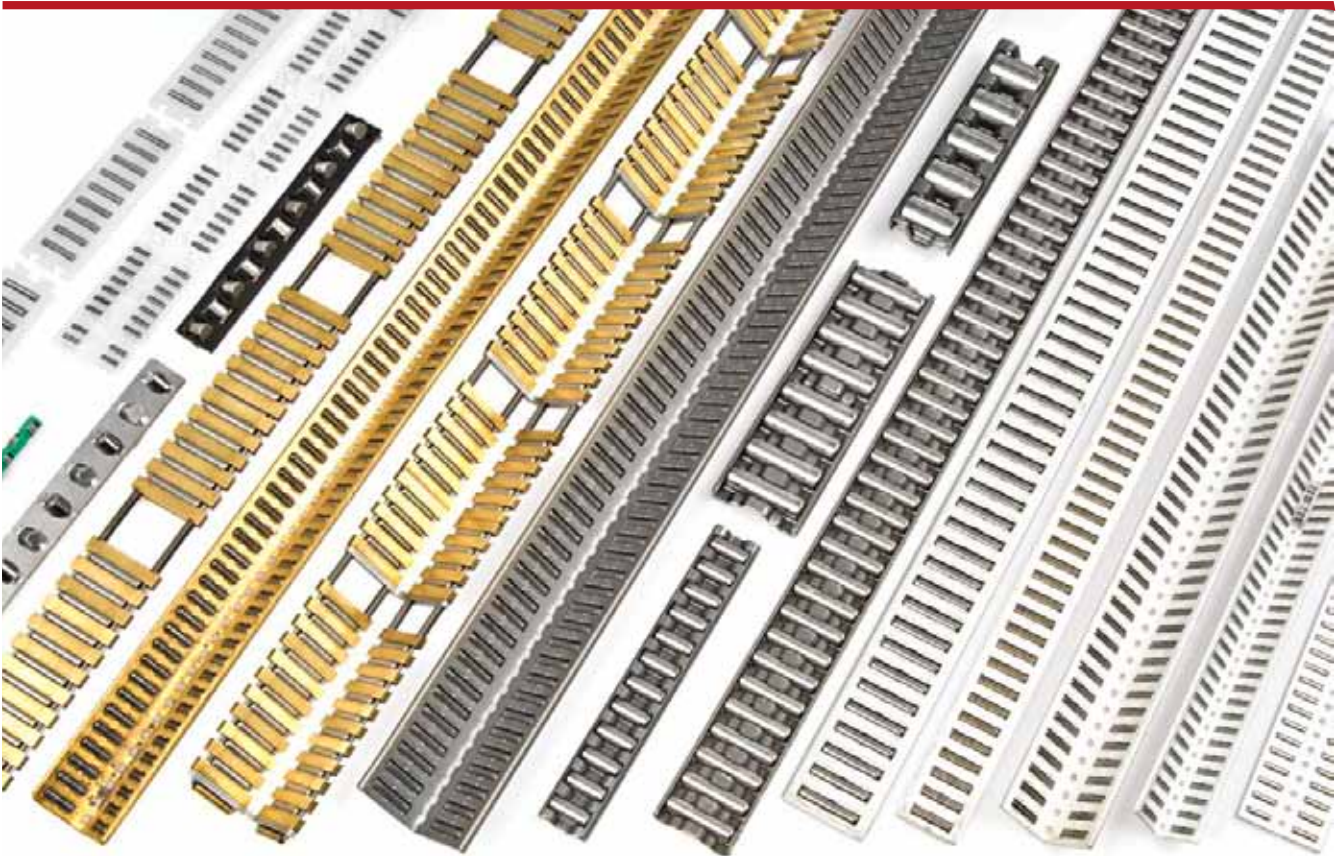

A GENERAL ASPECTS

Every cage type possesses specific technical characteristics and application features. The flat cage assemblies presented in the table below are intended for use with the guideways described in this catalogue. However, they can also run directly on raceways in connecting parts which fulfil the necessary characteristics.

The cage length can be adapted to the application in steps according to the spacing LA.

C MATERIAL

4 materials for flat basic cages:

- Aluminium (standard) for normal operating conditions and high accelerations
- Steel for difficult operating conditions (suffix "F")
- Plastic for easy operating conditions (series E-FF / E-FFW)
- Brass for special operating conditions (suffix "MS") (Standard for cages with damping)

B RACEWAY CHARACTERISTICS

The raceways must fulfil the same conditions as the raceways on the guideways

- Surface roughness $R_a \leq 0.35 \mu\text{m}$
- Hardness min. 58 HRC / 670 HV

(with lower hardness levels, the hardness factors according to figure 10 page 25 should be taken into account)

D ALTERNATIVE VERSIONS

- Higher precision of rolling elements (suffix G1)
- Corrosion-resistant cages (suffix BK)
- Friction-reducing coating (suffix BR)

DELIVERABLE CAGES

Flat cage material	Rolling elements			
	Type	Cage shape	Single row	Double row
Plastic	Needle rollers	Flat	E-FF	E-FF...ZW
		Angled		E-FFW
Aluminium	Needle rollers	Flat	E-H	E-H ZW
		Angled		E-HW
	Cylindrical rollers	Flat	E-HR	E-HR ZW
		Angled		E-HRW
	Balls	Flat	E-HB	
		Angled		E-HBW
Steel	Needle rollers	Flat	E-H F	E-H ZW F
		Angled		E-HW F
		Profiled sheet	E-BF	
Brass	Needle rollers	Flat	E-H MS	E-H ZW MS
		Angled		E-HW MS
	Needle rollers with damping	Flat	E-HG	
		Angled		E-HGW

ACCURACY OF THE ROLLING ELEMENTS

Rolling elements	According to DIN standard	Quality category	Roundness μm	Category tolerance μm
Needle rollers	DIN 5402-3	G2 (standard)	1	2
		G1	0.5	1
Cylindrical rollers	DIN 5402-1	GN	1	2
		G1	0.5	1
Balls	DIN 5401	G5	0.13	1

E SINGLE-ROW FLAT CAGE ASSEMBLIES

E-FF

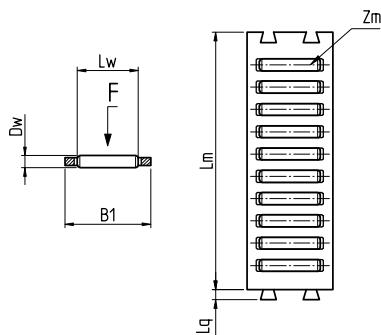

E-H, E-BF, E-H F, E-H MS

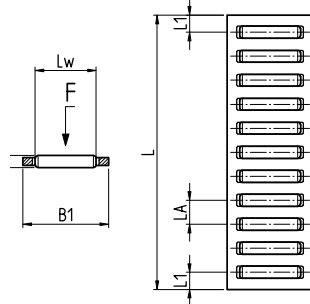

E-HR

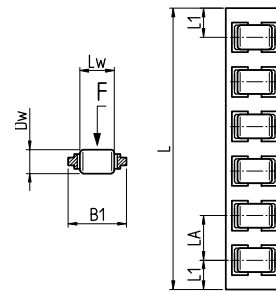

F = Load direction

DIMENSIONS IN MM

Rolling element diameter	Type				Dimensions							Number of rolling elements per row	Basic load ratings***		
	E-FF	E-H E-H F E-H MS	E-BF	E-HR	B1*	Lw	LA	L1	Lq	L**	Lm		Zm	C	Co
2	E-FF2010				10	6.8				2		32	7	21'160	61'900
		E-H10			10	6.8	4.5	3.5		2000				21'410	62'900
2.5	E-FF2515				15	9.8			2.5		45	8	32'600	92'300	
		E-H15			15	9.8	5	3.5		2000				35'620	103'900
3	E-FF3020				20	13.8			3		60	9	47'880	133'300	
		E-H20			20	13.8	6	4.5		2000				51'830	148'100
			E-BF3020		20	15.8	6	4.5		2000				57'750	170'200
3.5	E-FF3525				25	17.8			3		75	10	64'990	177'400	
		E-H25			25	17.8	7	5		2000				68'450	190'100
5				E-HR50	10.5	5	10	6.5		2000				29'400	50'800
			E-BF5015		15	11.8	8	5.5		2000				70'410	154'700
			E-BF5023		23	19.8	8	5.5		2000				107'080	265'200
			E-BF5032		32	27.8	8	5.5		2000				140'400	375'700
7				E-HR70	17	10	13	8.5		2000				65'800	114'200
			E-BF7028		28	24	11	7.5		2000				153'000	331'900
			E-BF7035		35	30	11	7.5		2000				182'480	416'300
10				E-HR100	24	14	17	10		2000				109'900	174'200
12			E-BF12022		22	18	16	10		2000				183'000	288'400
			E-BF12040		40	36	16	10		2000				317'950	586'800

* Mounting dimensions: see table, page 82

** Length tolerance: 0/-1*LA

*** Basic load ratings for a theoretical cage length of 100mm in load direction "F"

F DOUBLE-ROW FLAT CAGE ASSEMBLIES

E-FF ZW

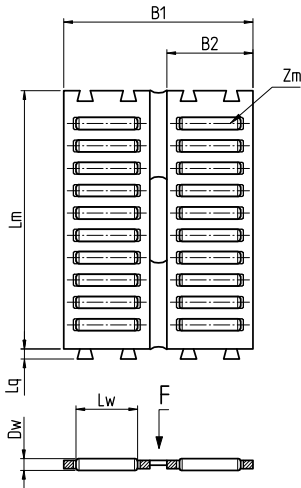

E-H ZW, E-H ZW F, E-H ZW MS

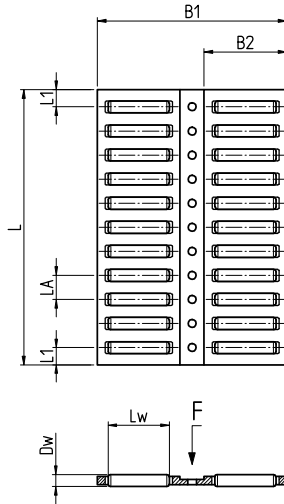

E-HR ZW

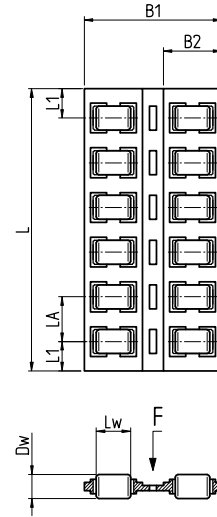

F = Load direction

DIMENSIONS IN MM

Rolling element diameter	Type			Dimensions								Number of rolling elements per row	Basic load ratings***	
	E-FF ZW	E-H ZW E-H ZW F E-H ZW MS	E-HR ZW	B1*	B2	Lw	LA	L1	Lq	L**	Lm		Zm	C
2		E-H19 ZW F		19.2	8	4.8	4	3		1000			29'960	97'200
	E-FF2025 ZW			25	10	6.8			2		32	7	36'280	123'800
		E-H24 ZW		24	10.5	6.8	4.5	3.5		2000			36'710	125'700
2.5	E-FF2535 ZW			35	15	9.8			2.4		45	8	55'900	184'700
		E-H34 ZW		33.5	14.3	9.8	5.5	4		2000			56'850	188'900
3	E-FF3045 ZW			45	20	13.8			3		60	9	82'090	266'500
		E-H44 ZW		44	19	13.8	6	4.5		2000			88'860	296'100
3.5	E-FF3555 ZW			55	25	17.8			3.2		75	10	111'420	354'800
		E-H55 ZW		55	24	17.8	7	5		2000			117'360	380'100
5			E-HR50 ZW	24	10.5	5	10	6.5		2000			51'080	101'700
7			E-HR70 ZW	40	17	10	13	8.5		2000			114'900	228'500
10			E-HR100 ZW	55	24	14	17	10		2000			193'110	348'400

* Mounting dimensions: see table, page 83

** Length tolerance: 0/-1*LA

*** Basic load ratings for a theoretical cage length of 100mm in load direction "F"

G ANGLED FLAT CAGE ASSEMBLIES

E-FFW

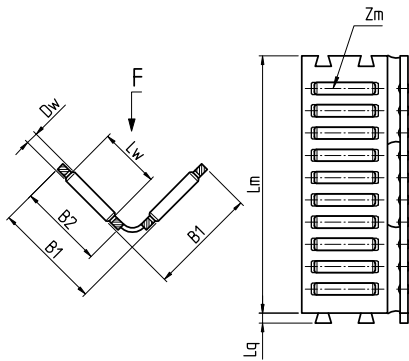

E-HW, E-HW F, E-HW MS

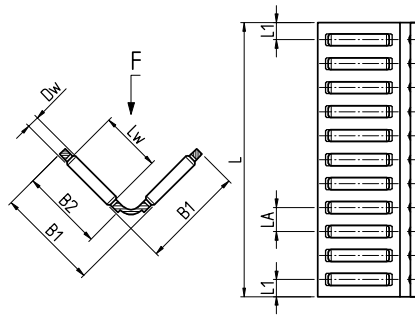

E-HRW

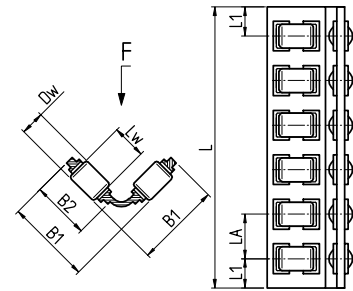

F = Load direction

DIMENSIONS IN MM

Rolling element diameter	Type			Dimensions								Number of rolling elements per row	Basic load ratings**		
	Dw	E-FFW	E-HW E-HW F E-HW MS	E-HRW	B1	B2	Lw	LA	L1	Lq	L*		Lm	Zm	C
											max.			N	N
2		E-HW10 F			10	8	4.8	4	3		1000			21'190	68'800
		E-FFW2025			15	10	6.8			2		32	7	25'650	87'500
		E-HW15			14	10.5	6.8	4.5	3.5		2000			25'960	88'900
		E-HW16			16	13.5	8.8	3.8	2.8		2000			36'410	138'200
2.5		E-FFW2535			20.5	15	9.8			2.4		45	8	39'530	130'600
		E-HW20			20	14.3	9.8	5.5	4		2000			40'200	133'500
3		E-FFW3045			26	20	13.8			3		60	9	58'050	188'500
		E-HW25			25	19	13.8	6	4.5		2000			62'840	209'400
3.5		E-FFW3555			31.5	25	17.8			3.2		75	10	78'790	250'900
		E-HW30			30	24	17.8	7	5		2000			82'980	268'800
5			E-HRW50	15.5	10.5	5	10	6.5			2000			36'120	71'900
7			E-HRW70	25	17	10	13	8.5			2000			81'240	161'600
10			E-HRW100	34	24	14	17	10			2000			136'550	246'400

* Length tolerance: 0/-1*LA

** Basic load ratings for a theoretical cage length of 100mm in load direction "F"

H BALL FLAT CAGE ASSEMBLIES

E-HB

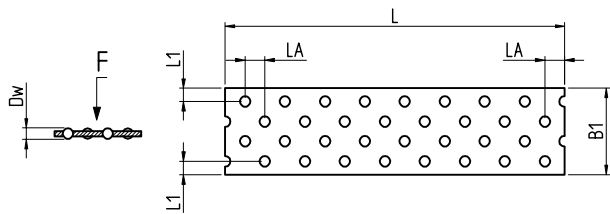

E-HBW

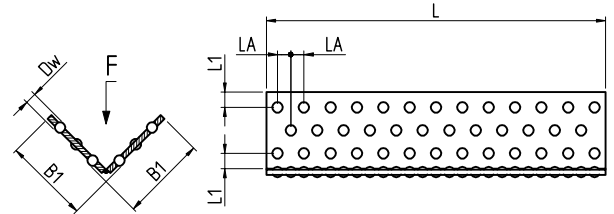

F = Load direction

DIMENSIONS IN MM

Ball diameter	Type		Dimensions				Basic load ratings**	
	E-HB	E-HBW	B1	LA	L1	L* max.	C	Co
2	E-HB2515		15	3	4.5	2000	3'180	3'040
3	E-HB3020		20	3.5	4	2000	5'140	5'000
		E-HBW3x18x18	17.75	3.5	3.5	1000	5'970	5'020
	E-HB3023		23	3.5	5.5	2000	5'140	5'000
		E-HBW3x23x23	22.75	3.5	4	1000	7'300	6'690
4	E-HB4025		25	5	5	2000	7'410	6'220

* Length tolerance: 0/-1*LA

** Basic load ratings for a theoretical cage length of 100mm in load direction "F"

FLAT CAGE ASSEMBLIES WITH DAMPING

E-HG

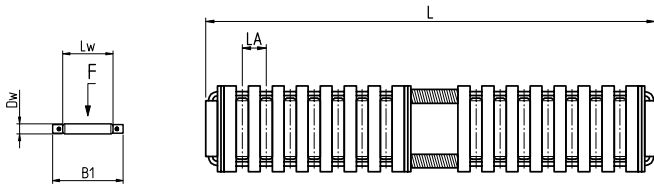

E-HGW

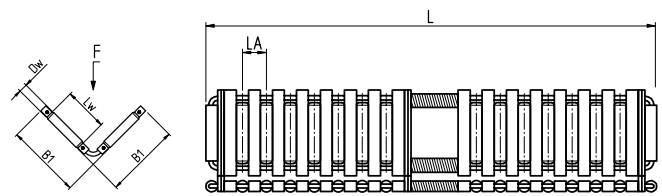

F = Load direction

DIMENSIONS IN MM

Needle roller diameter	Type		Dimensions				Basic load ratings**		Damping power
	E-HG	E-HGW	B1*	Lw	LA	L max.	C N	Co N	RS***
2	E-HG10		10	6.3	4.5	2000	18'210	50'800	4.5
		E-HGW15	13.5	6.3	4.5	1500	21'760	70'500	9
2.5	E-HG15		15	9.8	5	2000	31'630	88'700	8
		E-HGW20	19.5	9.8	5	1500	37'970	123'800	16
3	E-HG20		20	13.8	6	2000	47'780	132'900	11
		E-HGW25	25	13.8	6	1500	57'370	185'500	22
3.5	E-HG25		25	17.8	7	2000	61'740	165'700	14
		E-HGW30	30.5	17.8	7	1500	74'320	232'100	28

* Mounting dimensions: see table page 82

** Basic load ratings for a theoretical cage length of 100mm in load direction "F"

*** For a cage length of 100mm.

Calculation of the damping power for the effective cage length =>RSw=RS* $\frac{L}{100}$

J MOUNTING DIMENSIONS

SINGLE-ROW FLAT CAGE ASSEMBLY

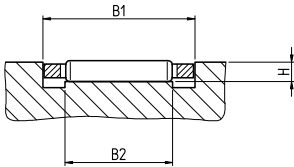

Cage type					Mounting dimensions in mm		
E-FF	E-H E-H F E-H MS	E-BF	E-HR	E-HG	B1	B2 min.	H
E-FF2010	E-H10			E-HG10	10.3 ^{+0.2/0}	7	1.7
E-FF2515	E-H15			E-HG15	15.3 ^{+0.2/0}	10	2.2
E-FF3020	E-H20			E-HG20	20.4 ^{+0.2/0}	14	2.7
		E-BF3020			20.4 ^{+0.2/0}	16	2.7
E-FF3525	E-H25			E-HG25	25.4 ^{+0.2/0}	18	3.2
			E-HR50		10.9 ^{+0.2/0}	5	3.4
		E-BF5015			15.3 ^{+0.2/0}	12	4.6
		E-BF5023			23.4 ^{+0.2/0}	20	4.6
		E-BF5032			32.5 ^{+0.3/0}	28	4.6
			E-HR70		17.4 ^{+0.2/0}	10	4.8
		E-BF7028			28.4 ^{+0.2/0}	24	6.5
		E-BF7035			35.6 ^{+0.3/0}	30	6.5
			E-HR100		24.4 ^{+0.2/0}	14	6.5
		E-BF12022			22.4 ^{+0.2/0}	18	11
		E-BF12040			40.5 ^{+0.3/0}	36	11

J MOUNTING DIMENSIONS

DOUBLE-ROW FLAT CAGE ASSEMBLY

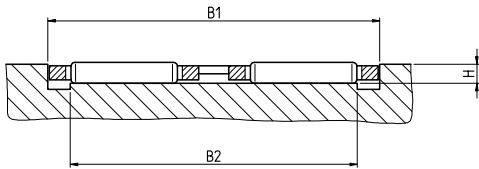

Cage type			Mounting dimensions in mm		
E-FF ZW	E-H E-H F E-H MS	E-BF	B1	B2	H
	E-H19 ZW F		19.6 ^{+0.2/0}	17	1.7
E-FF2025 ZW			25.4 ^{+0.2/0}	22	1.7
	E-H24 ZW		24.4 ^{+0.2/0}	21	1.7
E-FF2535 ZW			35.5 ^{+0.2/0}	30	2.2
	E-H34 ZW		34.0 ^{+0.2/0}	28.5	2.2
E-FF3045 ZW			45.5 ^{+0.2/0}	39	2.7
	E-H44 ZW		44.5 ^{+0.2/0}	38	2.7
E-FF3555 ZW	E-H55 ZW		55.5 ^{+0.2/0}	48	3.2
		E-HR50 ZW	24.4 ^{+0.2/0}	19.5	3.4
		E-HR70 ZW	40.5 ^{+0.2/0}	34	4.8
		E-HR100 ZW	55.5 ^{+0.2/0}	46	6.5

K DELIVERABLE CAGE ASSEMBLIES

Flat cage material	Rolling elements	Cage shape	Number of rows	Designation	Dimensions	Weight per metre (g)	Guideway allocation
Plastic	Needle rollers	Flat	1	E-FF	E-FF2010	46	S3525, J3525
					E-FF2515	84	S4025, J4025, S5025, J5025
					E-FF3020	148	S5030, J5030
					E-FF3525	221	S5530, J5530
		Flat	2	E-FF ZW	E-FF2025 ZW	94	Special guideways
					E-FF2535 ZW	182	Special guideways
					E-FF3045 ZW	315	Special guideways
					E-FF3555 ZW	464	Special guideways
		Angled	2	E-FFW	E-FFW2025	94	M4020, V4020, M5025, V5025, ML5020, ML5520, ML5525, ML6025, ML6525, ML7025
					E-FFW2535	182	M6035, V6035, ML7035, ML8035
					E-FFW3045	315	M7040, V7040, ML8040, ML9040
					E-FFW3555	464	M8050, V8050, ML9050, ML10050
		Aluminium	Needle rollers	Flat	1	E-H	E-H10
E-H15	120						S4025, J4025, S5025, J5025, LUE5025
E-H20	202						S5030, J5030
E-H25	294						S5530, J5530
Flat	2			E-H ZW	E-H24 ZW	138	S6035, J6035, LUE6035
					E-H34 ZW	239	S7040, J7040, LUE7040
					E-H44 ZW	408	S8050, J8050, LUE8050
					E-H55 ZW	598	Special guideways
Angled	2			E-HW	E-HW15	138	M4020, V4020, M5025, V5025, ML5020, ML5520, ML5525, ML6025, ML6525, ML7025, LUE5025
					E-HW16	190	M5025, V5025, ML5525, ML6025, ML6525, ML7025
					E-HW20	239	M6035, V6035, ML7035, ML8035, LUE6035
					E-HW25	408	M7040, V7040, ML8040, ML9040, LUE7040
					E-HW30	598	M8050, V8050, ML9050, ML10050, LUE8050
Cylindrical rollers	Flat		1	E-HR	E-HR50	105	Special guideways
					E-HR70	295	Special guideways
					E-HR100	598	Special guideways
	Flat		2	E-HR ZW	E-HR50 ZW	215	Special guideways
					E-HR70 ZW	602	Special guideways
					E-HR100 ZW	1233	Special guideways
	Angled		2	E-HRW	E-HRW50	215	M4525, V4525
		E-HRW70			602	M6535, V6535	
		E-HRW100			1233	M8550, V8550	
Balls	Flat	1	E-HB	E-HB2515	95	S4025, J4025, S5025, J5025	
				E-HB3020	167	S5030, J5030	
				E-HB3023	187	Special guideways	
				E-HB4025	250	S5530, J5530	
	Angled	2	E-HBW	E-HBW3x18x18	300	Special guideways	
				E-HBW3x23x23	480	Special guideways	

Flat cage material	Rolling elements	Cage shape	Number of rows	Designation	Dimensions	Weight per metre (g)	Guideway allocation	
Steel	Needle rollers	Flat	1	E-H F	E-H10 F	127	S3525, J3525, LUE5025	
					E-H15 F	224	S4025, J4025, S5025, J5025, LUE5025	
					E-H20 F	369	S5030, J5030	
					E-H25 F	546	S5530, J5530	
		Profiled sheet	1	E-BF	E-BF3020	342	S5030, J5030	
					E-BF5015	375	LUE6035, LUE7040, LUE8050	
					E-BF5023	530	Special guideways	
					E-BF5032	722	Special guideways	
					E-BF7028	875	Special guideways	
					E-BF7035	1080	Special guideways	
					E-BF12022	1220	Special guideways	
		Flat	2	E-H ZW F	E-BF12040	1970	Special guideways	
					E-H19 ZW F	219	Special guideways	
					E-H24 ZW F	289	S6035, J6035, LUE6035	
					E-H34 ZW F	471	S7040, J7040, LUE7040	
					E-H44 ZW F	756	S8050, J8050, LUE8050	
		Angled	2	E-HW F	E-H55 ZW F	1117	Special guideways	
					E-HW10 F	219	M3015, V3015	
					E-HW15 F	289	M4020, V4020, M5025, V5025, ML5020, ML5520, ML5525, ML6025, ML6525, ML7025, LUE5025	
					E-HW20 F	471	M6035, V6035, ML7035, ML8035, LUE6035	
E-HW25 F	756				M7040, V7040, ML8040, ML9040, LUE7040			
Brass	Needle rollers	Flat	1	E-H MS	E-HW30 F	1117	M8050, V8050, ML9050, ML10050, LUE8050	
					E-H15 MS	234	S4025, J4025, S5025, J5025, LUE5025	
					E-H20 MS	389	S5030, J5030	
		Flat	2	E-H ZW MS	E-H25 MS	575	S5530, J5530	
					E-H19 ZW MS	230	Special guideways	
					E-H24 ZW MS	306	S6035, J6035, LUE6035	
					E-H34 ZW MS	499	S7040, J7040, LUE7040	
					E-H44 ZW MS	798	S8050, J8050, LUE8050	
		Angled	2	E-HW MS	E-H55 ZW MS	1178	Special guideways	
					E-HW10 MS	230	M3015, V3015	
					E-HW15 MS	306	M4020, V4020, M5025, V5025, ML5020, ML5520, ML5525, ML6025, ML6525, ML7025, LUE5025	
					E-HW16 MS	390	M5025, V5025, ML5525, ML6025, ML6525, ML7025	
					E-HW20 MS	499	M6035, V6035, ML7035, ML8035, LUE6035	
					E-HW25 MS	798	M7040, V7040, ML8040, ML9040, LUE7040	
					E-HW30 MS	1178	M8050, V8050, ML9050, ML10050, LUE8050	
		Needle rollers with damping	Flat	1	E-HG	E-HG10	130	S3525, J3525, LUE5025
						E-HG15	230	S4025, J4025, J5025, LUE5025
						E-HG20	375	S5030, J5030
						E-HG25	560	S5530, J5530
			Angled	2	E-HGW	E-HGW15	265	M4020, V4020, M5025, V5025, ML5020, ML5520, ML5525, ML6025, ML6525, ML7025, LUE5025
E-HGW20	470					M6035, V6035, ML7035, ML8035, LUE6035		
E-HGW25	760					M7040, V7040, ML8040, ML9040, LUE7040		
E-HGW30	1150					M8050, V8050, ML9050, ML10050, LUE8050		

9

ACCESSORIES

END PIECES / WIPERS FOR
GUIDEWAYS / ESM INSERT
NUTS FOR GUIDEWAYS

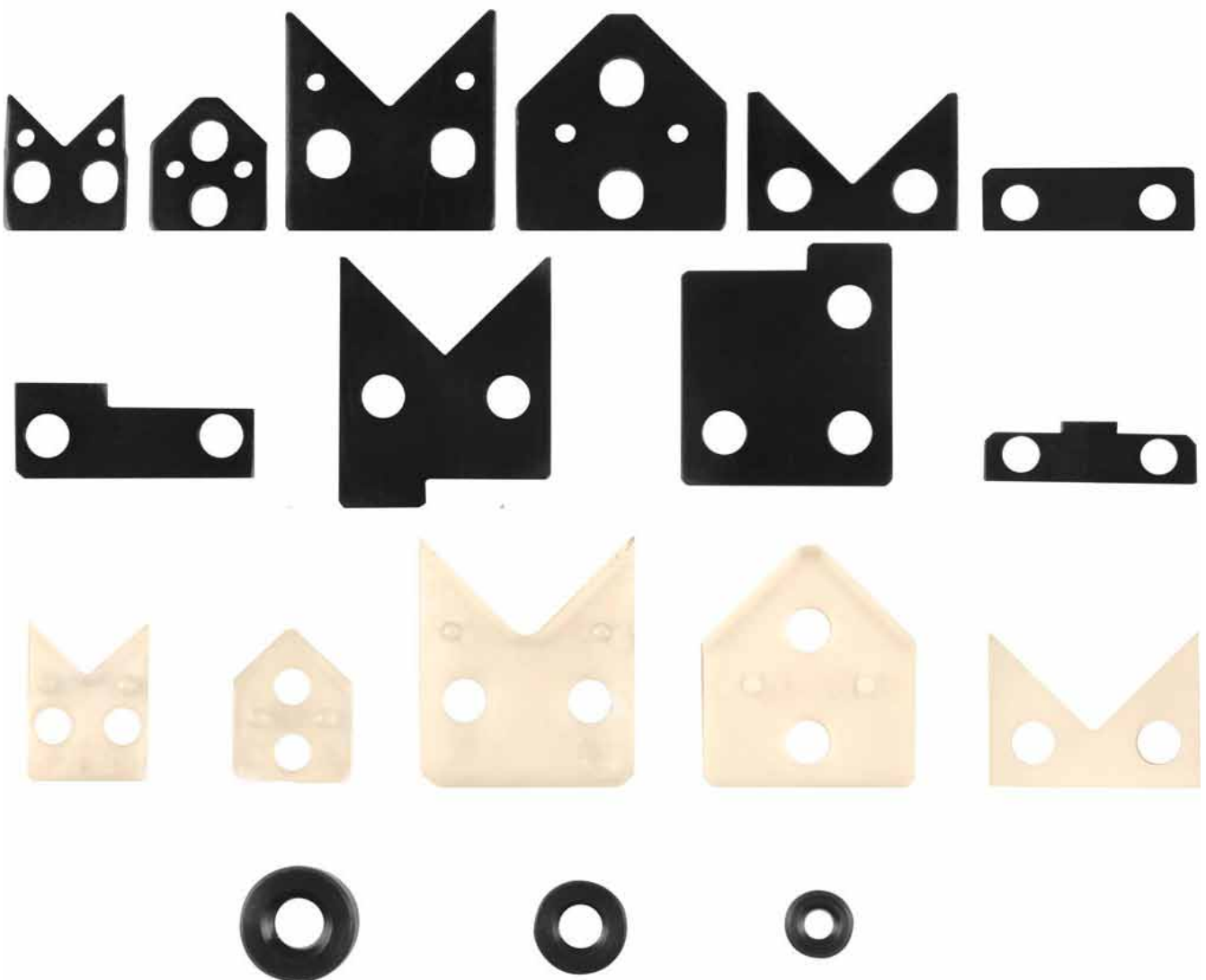

END PIECES

Conditioning: end piece with fixing screws

- MATERIAL

Blackened construction steel St 37-2
Fixing screws ISO 7984

IMPORTANT INFORMATION: the end pieces must not be used to limit the stroke.

WIPERS

Conditioning: end piece with assembled wiper plate and fixing screws

- MATERIAL

Blackened construction steel St 37-2
Polyester elastomer
Fixing screws ISO 7984

Longitudinal seals may also be applied in order to reduce the risk of soiling on the raceways.

ESM INSERT NUTS

Standard guideways are delivered with sinkholes (T15). These guideways can be attached as with a threaded hole (T03) by using ESM insert nuts. The insert nuts must be glued into the hole (T13).

The ESM insert nuts should be ordered separately and are delivered loose.

- MATERIAL

Heat-treatable steel CK 45 (1.1191)

END PIECES

EV TYPE

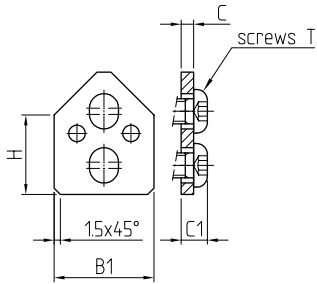

EM TYPE

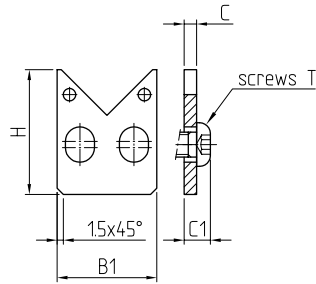

EML TYPE

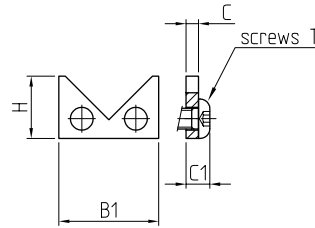

EJ TYPE

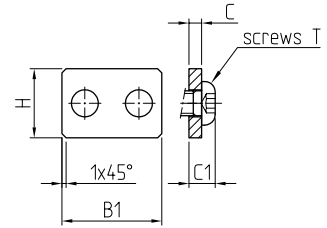

DIMENSIONS IN MM

Guideways	Designation				Dimensions				T screws
	EV	EM	EML	EJ	B1	H	C	C1 max.	DIN 7984
V 3015	EV3015				14	12.6	2	5	M3x6
V 4020	EV4020				19	14.9	3	7	M5x10
V 4525	EV4525				24	18.5	3	7.5	M6x10
V 5025	EV5025				24	17.8	3	7.5	M6x10
V 6035	EV6035				34	21.5	3	7.5	M6x10
V 6535	EV6535				34	27.5	3	7.5	M6x10
V 7040	EV7040				39	26.2	3	7.5	M6x10
V 8050	EV8050				49	29	3	7.5	M6x10
V 8550	EV8550				49	37.5	3	7.5	M6x10
M 3015		EM3015			14	16.7	2	5	M3x6
M 4020		EM4020			19	23	3	7	M5x10
M 4525		EM4525			24	26.5	3	7.5	M6x10
M 5025		EM5025			24	29	3	7.5	M6x10
M 6035		EM6035			34	36	3	7.5	M6x10
M 6535		EM6535			34	40.5	3	7.5	M6x10
M 7040		EM7040			39	42	3	7.5	M6x10
M 8050		EM8050			49	49	3	7.5	M6x10
M 8550		EM8550			49	54.5	3	7.5	M6x10
ML5020, ML 5520			EML 20		19	12	3	6.5	M4x10
ML 5525 to ML 7025			EML 25		24	15	3	7	M5x10
ML 7035, ML 8035			EML 35		34	23	3	7.5	M6x10
ML 8040, ML 9040			EML 40		39	28.5	3	7.5	M6x10
ML 9050, ML 10050			EML 50		49	35	3	7.5	M6x10
J 3525				EJ 35	34	11	3	7	M5x10
J 4025				EJ 40	39	12	3	7	M5x10
J 5030				EJ 50	49	14	3	7.5	M6x10
J 5530				EJ 55	54	15	3	7.5	M6x10
J 5025				EJ 5025	24	16.6	3	7.5	M6x10
J 6035				EJ 6035	34	17	3	7.5	M6x10
J 7040				EJ 7040	39	16.8	3	7.5	M6x10
J 8050				EJ 8050	49	18.2	3	7.5	M6x10

END PIECES

ELU TYPE

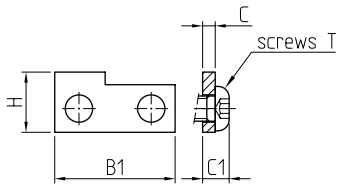

EMLU TYPE

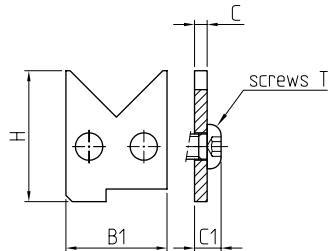

EJLU TYPE

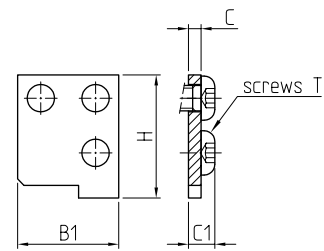

DIMENSIONS IN MM

Guideways	Designation			Dimensions				T screws
	ELU	EMLU	EJLU	B1	H	C	C1 max.	DIN 7984
LUE 5025	ELU 5025			28.6	11.3	3	7.5	M6x10
		EMLU5025		24	31.1	3	7.5	M6x10
			EJLU 5025	24	29.2	3	7.5	M6x10
LUE 6035	ELU 6035			38.6	13.8	3	7.5	M6x10
		EMLU6035		34	40.5	3	7.5	M6x10
			EJLU 6035	34	39	3	7.5	M6x10
LUE 7040	ELU 7040			38.6	15.8	3	7.5	M6x10
		EMLU7040		39	46.5	3	7.5	M6x10
			EJLU 7040	39	44	3	7.5	M6x10
LUE 8050	ELU 8050			49.6	18.8	3	7.5	M6x10
		EMLU8050		49	53.5	3	7.5	M6x10
			EJLU 8050	49	49	3	7.5	M6x10

WIPERS

EAV TYPE

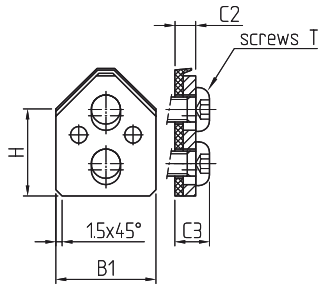

EAM TYPE

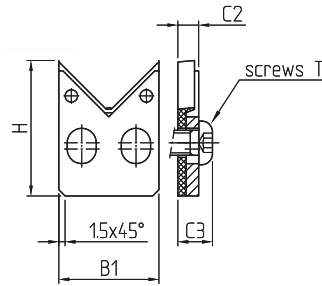

EAML TYPE

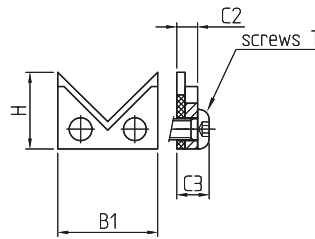

EAJ TYPE

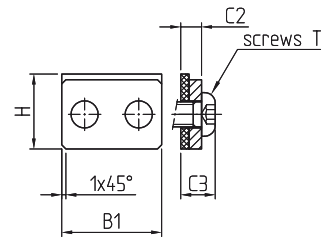

AFFILIATION TABLE

Guideways	End pieces with assembled wipers	Dimensions				T screws
		B1	H	C2	C3	DIN 7984
V 3015	EAV3015	14	13.4	4	7	M3x8
V 4020	EAV4020	19	16.7	5	9	M5x12
V 4525	EAV4525	24	21.2	5	9.5	M6x12
V 5025	EAV5025	24	19.9	5	9.5	M6x12
V 6035	EAV6035	34	23.7	5	9.5	M6x12
V 6535	EAV6535	34	30.2	5	9.5	M6x12
V 7040	EAV7040	39	28.4	5	9.5	M6x12
V 8050	EAV8050	49	31.2	5	9.5	M6x12
V 8550	EAV8550	49	40.2	5	9.5	M6x12
M 3015	EAM3015	14	18.6	4	7	M3x8
M 4020	EAM4020	19	25.7	5	9	M5x12
M 4525	EAM4525	24	30.2	5	9.5	M6x12
M 5025	EAM5025	24	32.2	5	9.5	M6x12
M 6035	EAM6035	34	39.2	5	9.5	M6x12
M 6535	EAM6535	34	44.2	5	9.5	M6x12
M 7040	EAM7040	39	45.2	5	9.5	M6x12
M 8050	EAM8050	49	53.2	5	9.5	M6x12
M 8550	EAM8550	49	58.2	5	9.5	M6x12
ML5020, ML 5520	EAML 20	19	14	5	8.5	M4x12
ML 5525 to ML 7025	EAML 25	24	18.4	5	9.0	M5x12
ML 7035 - ML 8035	EAML 35	34	25.7	5	9.5	M6x12
ML 8040, ML 9040	EAML 40	39	31.2	5	9.5	M6x12
ML 9050, ML 10050	EAML 50	49	39.6	5	9.5	M6x12
J 3525	EAJ 35	34	11.6	5	9	M5x12
J 4025	EAJ 40	39	12.3	5	9	M5x12
J 5030	EAJ 50	49	14.3	5	9.5	M6x12
J 5530	EAJ 55	54	14.8	5	9.5	M6x12
J 5025	EAJ 5025	24	16.9	5	9.5	M6x12
J 6035	EAJ 6035	34	17.3	5	9.5	M6x12
J 7040	EAJ 7040	39	17.1	5	9.5	M6x12
J 8050	EAJ 8050	49	18.7	5	9.5	M6x12

ESM INSERT NUTS

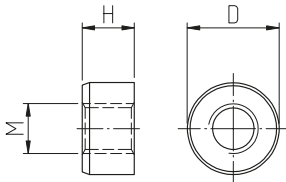

DIMENSIONS IN MM

Guideways	Designation	Dimensions		
	ESM	D -0.05/-0.10	H	M
M/V 3015	ESM M4	8.5	4.3	M4
S/J 3525 S/J 4025	ESM M5	10	5.5	M5
M/V 4020 - M/V 4525 - M/V 5025 S/J 5025 ML 5020 - ML 5520 ML 5525 - ML 6025 ML 6525 - ML 7025	ESM M6	11.5	6.5	M6
S/J 5030 - S/J 5530	ESM M6	11.0	6.5	M6
M/V 6035 - M/V 6535 S/J 6035 ML 7035 - ML 8035	ESM M8	15	8.5	M8
M/V 7040 S/J 7040 ML 8040 - ML 9040	ESM M10	18.5	10.5	M10
M/V 8050 - M/V 8550 S/J 8050 ML 9050 - ML 10050	ESM M12	20	12.5	M12

10

ALTERNATIVE VERSIONS

GROUP	DETAILS	CODE	
No threaded holes on front side	No threaded holes on both ends	E1	
	No threaded holes at beginning of the guideway (distance L1)	E1L	
	No threaded holes at end of the guideway	E1R	
Raceway lead areas at end of guideways	Raceway lead areas at both ends of the guideway	E2	
	Raceway lead area at beginning of the guideway (distance L1)	E2L	
	Raceway lead area at end of the guideway (distance L2)	E2R	
Position of fixing holes different from dimension table	Distance between the first hole and the start of the guideway	L1	
	Hole distance	LA	
	Distance between the last hole and the end of the guideway	L2	
Layout with longitudinal seal		Layout sealed with sealing strips made from plastic	PP
		Layout sealed with sealing strips made from a steel band	ZZ
Raceways with sliding layer	With Turcite sliding layer	LB	
	With Permaglide sliding layer	LP21	
Layout with integrated toothed rack	For positive control of flat cage assemblies	MVZ	

GROUP	DETAILS	CODE
Special treatments	Corrosion protection – thin layer chromium plating (layer thickness 2-5µm)	DSV
	Galvanising – nickel coating – blackening – sandblasting – trovalisation procedures, etc.	AVAILABLE ON REQUEST
Special tolerances	Pre-ground raceways	VQ10
	Special height dimension (H)	TH
	Restricted width tolerance	TB
	Restricted hole distance tolerance (LA)	P
	Lubrication holes or additional holes	TG
	Ground joints for multi-part guideways	E5
	Guideways with joints ground on both sides	E6
Different guideway materials	Stainless or other steel	AVAILABLE ON REQUEST

11

SPECIAL DESIGNS



GUIDEWAYS FOR CROSSED ROLLER AND BALL FLAT CAGE ASSEMBLIES R3/R6/R9...



GUIDEWAYS FOR HYDROSTATIC GUIDANCE SYSTEMS



GUIDEWAYS FOR AIR BEARINGS



SPECIFIC SHAPES AND DIMENSIONS



LINEAR RECIRCULATING ROLLER BEARINGS (RUSW + U-100)



SPECIAL MATERIALS

Stainless or other steel available on request